

tralift[®]

Manual Chain Hoists

Operation, Maintenance and Parts Manual

Rated Loads: 1/2, 1, 1 1/2, 2 , 3 / 5,10, 20 T

Meets or exceeds standards and requirements established by
ANSI standards SME B30.16 and HST-2M

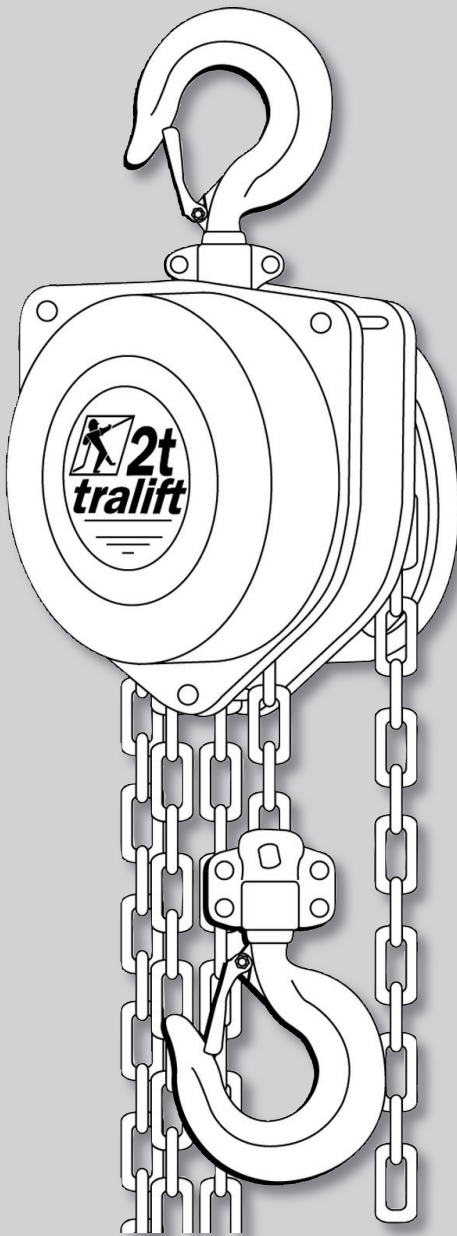

Before installing hoist, fill in the information below.

Rated Load: _____

Serial Number: _____

Purchase Date: _____



GENERAL WARNINGS

Follow the instructions and warnings for inspecting, maintaining and operating this hoist. The use of any hoist presents some risk of personal injury or property damage.

That risk is greatly increased if proper instruction and warnings are not followed. Before using this hoist, each operator should become thoroughly familiar with all warnings, instructions and recommendations in this manual.

**RETAIN THIS MANUAL FOR FUTURE
REFERENCE AND USE.**

Forward this manual to operator.
Failure to operate equipment as directed in manual
may cause serious injury or death.



WLL 500 lbs to 40,000 lbs

tralift®

Manual Chain Hoists

Operation, Maintenance and Parts Manual

Table of Contents





	Page		Page
1) Introduction	8	5) Maintenance	14
2) Installation	9	5.1) Removing the Handwheel Cover	14
3) Operation	9	5.2) Installing New Hand Chain	14
4) Inspection	10	5.3) Installing New Load Chain	15
4.1) Service Schedule	10	5.4) Installing a New Load Hook	16
4.2) Frequent Inspection	10	5.5) Brake Replacement	17
Operation		6) Troubleshooting	18
Hooks		7) Removal from service	18
Chain		and storage	
Lubrication		8) Product improvements	18
4.3) Periodic Inspection	10	9) Technical data	19
Load Block		9.1) New Style	20
Brake		Exploded View	
Chain Sheaves		9.2-9.7 New Style	21 - 26
Hooks		Spare Parts List	
Load Chain		10) Label & Tags	27
Hand Chain		11) Warranty information	32
Fasteners		11.1) Parts Depot & Service	32
Labels & Tags			
Supporting Structure			
4.4) Lubrication	13		
4.5) Testing	14		

tralift® - Manual Chain Hoists

Rated Loads: 1/2, 1, 1 1/2, 2 , 3 / 5,10, 20 T

IMPORTANT

This manual contains information describing inspection and repair procedures for the equipment described herein and is made available for qualified technicians only. To ensure proper safety, all persons involved in operation of this equipment must be properly trained and thoroughly familiar with the correct inspection and repair procedures. These persons shall also be familiar with all applicable ANSI standards (ASME B30.16 and HST-2M) and/or other federal, state, provincial and local standards which may apply.

Explanation of Symbols used in this manual			
Symbol	Code Word	Meaning	Possible consequence of non-compliance
	WARNING	IMMEDIATE or possibly imminent danger:	Fatal or serious injuries!
	CAUTION	Possibly dangerous situation:	Minor injuries to persons!
	NOTE	Possibly dangerous situation:	Damage to equipment or it's surroundings
	n/a	Instruction for documentation in writing (i.e record keeping)	n/a





GENERAL WARNING

READ THIS GENERAL WARNING FIRST

IN HOISTING OPERATIONS, SAFETY AND PROPER OPERATION IS A MATTER OF LIFE OR DEATH FOR RIGGERS, OPERATORS AND BY-STANDARDS. THIS WARNING IS YOUR SHARE OF DUTIES FOR ACHIEVING SAFETY.

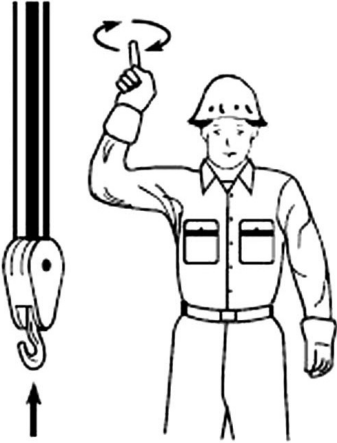
STANDARD HAND SIGNALS FOR CONTROLLING HOISTS

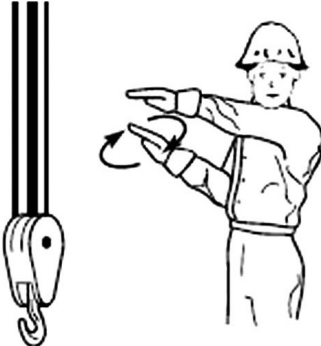
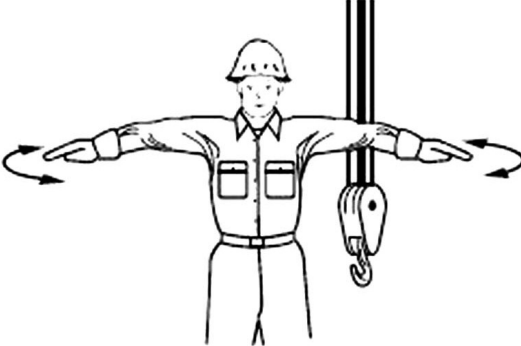
 <p>HOIST. With forearm vertical, forefinger pointing up, move hand in small horizontal circle.</p>	 <p>LOWER. With arm extended downward, forefinger pointing down, move hand in small horizontal circle.</p>	 <p>STOP. Arm extended, palm down, move arm back and forth horizontally.</p>
 <p>MOVE SLOWLY. Use one hand to give any motion signal and place other hand motionless in front of hand giving the motion signal. (Hoist slowly shown as example.)</p>	 <p>EMERGENCY STOP. Both arms extended, palms down, move arms back and forth horizontally.</p>	





GENERAL WARNING

READ THIS GENERAL WARNING FIRST

In hoisting operations, safety and proper operation is a matter of life or death for riggers, operators and by-standers. This warning is your share or duties for achieving safety.

YOUR DUTY TO UNDERSTAND AND COMPLY

- 1) It is the rigger's and the operators' responsibility, and their employer's responsibility, if they operate under an employer's control, to strictly conform to the following warnings. Be familiar with and understand hand signals.
- 2) It is imperative for safety and efficiency of the operations that this manual be read and FULLY UNDERSTOOD by the rigger and the operator before rigging or operating the tralift. ALL INSTRUCTIONS contained herein must be carefully and strictly FOLLOWED, including applicable guidelines for safe practice.
- 3) Should you hand over a tralift, under whatever conditions, to any party operating out of your control, you must join a clean copy of this manual and draw other party's attention that strictly following all the instructions therein is a matter of life or death.
- 4) Before rigging and operating this tralift hoist, the rigger and the operator must become aware of all the requirements of federal, state, provincial and local safety regulations not only applicable to the tralift hoist but also to the entire suspended system and any component of it.
- 5) Tralift may be used in the design and manufacture of cranes or monorails. Additional equipment or devices may be required for crane and monorail to comply with applicable crane design and safety standards. The crane designer, crane manufacturer, or user is responsible for furnish these additional items for compliance. Refer to ANSI/ASME B30.17, "Safety Standard For Top-Running Single Girder Cranes", ANSI/ASME B30.2 "Safety Standard For Top-Running Double Girder Cranes", and ANSI/ASME B30.11 "Safety Standard For Underhung Cranes and Monorails"
- 6) Never use the tralift hoist for any job other than lifting materials according to the instructions of this manual.
- 7) Never lift people or near people. Warn people of an approaching load.
- 8) Never use a tralift hoist which has been modified.
- 9) Never load the tralift hoist above its rated load capacity.
 - a) minimize swing the load or load hook.
 - b) maintain firm footing when operating lifting equipment.
 - c) avoid sudden acceleration and deceleration.

- d) concentrate on operating the hoists, and do not allow attention to be diverted while operating the equipment.
- e) stop hoist in a controlled manner when the operator has doubt as to the safety of the operations. Lift operations shall resume only after safety concerns have been addressed.
- f) lift the load block above the highest moveable obstruction under the hoist when the hoist not in use

10. Never use the tralift® if the load is NOT free to move.

YOUR DUTY TO INSPECT AND MAINTAIN

- 11) Keep this manual available at all times for easy reference whenever required. Extra Copies are available from the supplier.
12. Carefully take notice of all the labels and name plates fixed to the tralift® (see page 21). Never rig or operate the hoist if any label or nameplate, normally fixed on the hoist is obscured or missing. Tractel® will supply extra labels and nameplates on customer's request.
- 13) A careful and regular inspection of the tralift® hoist, its load chain, hooks and other components of the installation is part of the safety requirements. If you have any questions, call Tractel®
- 14) A careful and regular inspection of the tralift hoist, its load chain and other Components of the installation is part of the safety requirements. If you have any question, call the supplier.
- 15) Do not use a hoist with twisted, kinked, damaged or worn load chain.
- 16) Shut down a hoist that malfunctions or performs unusually and report such malfunction.
- 17) Do not attempt to lengthen or repair load chain.
- 18) Make sure hoist limit switches function properly.
- 19) Do not use a hoist with twisted, kinked, damaged or worn load chain.
- 20) Shut down a hoist that malfunctions or performs unusually and report such malfunction.
- 21) Do not attempt to lengthen or repair load chain.
- 22) Make sure hoist limit switches function properly.



YOUR DUTY TO TRAIN AND CONTROL PEOPLE

- 23) An operator must not be assigned to a hoisting job or to rigging for the job, if that person is not :
 - a) mentally or physically fit for that purpose
 - b) competent for the job to be performed
 - c) familiar with all applicable safety rules and requirements
 - d) familiar with the scaffold equipment as rigged
 - e) nothing trained for working under the above requirements.
- 24) Never disassemble the tralift by yourself or by your staff. Except for the operations described in this manual, the maintenance of the tralift hoists, as well as disassembly and repair, must be exclusively done by qualified repairers authorized in writing by the supplier. tralift spare parts in accordance with the serial number of each machine must be exclusively utilized. No substitutions are allowed.
- 25) Never let the tralift hoist and other equipment of a suspended system be managed or operated by a person other than authorized and assigned to the job.
- 26) Operator training must be set up by a competent person of the company, or of its technical consultant, according to the working conditions, prior to putting the equipment into operation : contact **TRACTEL Inc.**
- 27) Every suspended job must be placed under the control of a person having the required competence and the authority for checking that all the instructions prescribed by this manual be regularly and efficiently carried out.

YOUR DUTY OF SAFETY BEYOND THE tralift®

As being only one piece of the system, the tralift hoist can contribute to the required SAFETY ONLY, IF ...

- 28) it is fitted on compatible equipment.
- 29) Other components meet the requirements of the applicable safety regulations and are of the proper quality, and assembled to form a safe system.
- 30) Every upper support is stable, sufficiently strong, according to the load either static and dynamic.
- 31) Supporting structure provides the requested resistance to every load to be applied either static or dynamic, during operating the equipment.
- 32) All the requirements in strength and resistance are obtained with the necessary safety factor (see regulations and professional standards).
- 33) All the calculations, design and subsequent work necessary to the above requirements have been made by a competent person on the basis of proper technical information regarding the site.

YOUR DUTY TO AVOID TAKING CHANCES

- 34) Do not leave load supported by the hoist unattended unless specific precautions have been taken.
- 35) Should you decide that the tralift hoist is no longer to be used, take precautions in disposing of it so that it cannot be used anymore.
- 36) Tralift hoist **MUST NOT** be used in explosive atmosphere. It has not been designed for such an application.
- 37) Do not operate unless load is centered under hoist.
- 38) Protect the hoists load chain from weld splatter or other damaging contaminants.
- 39) Do not operate hoist when it is restricted from forming a straight line from hook to hook or lug to hook (optional) in the direction of loading.
- 40) Do not use load chain as a sling or wrap chain around load.
- 41) Do not apply the load to the tip of the hook or to the hook latch.
- 42) Never operate a hoist unless load slings or other approved attachments are properly sized and seated in the hook saddle.

FOR LIFTING PEOPLE OR OTHER APPLICATIONS CONTACT:
Tractel® Inc. for USA
or
Tractel® Ltd. for Canada

AN ULTIMATE RECOMMENDATION

Never neglect means to improve safety. Due to the risks inherent in the use of lever hoists, the supplier strongly recommends that every* bravo® lever hoist be fitted with an optional overload device when one is available. Ask your supplier for information on the optional overload device.

In order to keep improving its products, Tractel® reserves its right to apply any modification at any time to the product described in this manual.

The companies of The Tractel® Group and their appointed repairers will supply on request their documentation regarding other Tractel® products available: lifting and pulling machine and their accessories, site and facade access equipment, handling equipment, safety devices for load, personal fall protection equipment, load and tension indicators, etc.

Go to www.tractel.com

The Tractel® network can supply an after sales and periodic inspection service.

** Not available in the 1/4T and 1T models*



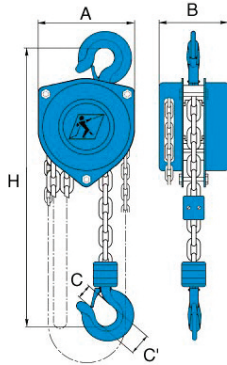

WLL 500 lbs to 4000 lbs

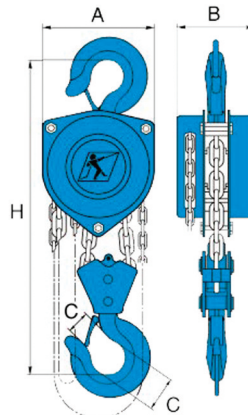

WLL 4000lbs to 10.000 lbs

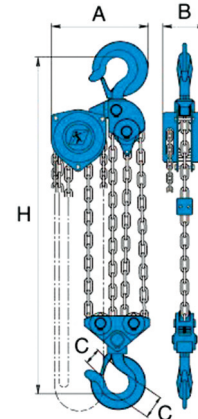

WLL 20.000 lbs

WLL lbs	No. of falls	Hand maxi load (lbs)	Load chain (inch)	Hand chain (inch)	Hoist weight + chain (lbs)	Weight of chain** suppl. by m (lbs)	Dimensions			
							A (inch)	B (inch)	C (inch)	H mini (inch)
500	1	24.25	0.16x0.47	0.09x0.55	8.82	1.19	3.94	4.33	0.61	9.06
1000	1	46.30	0.20x0.59	0.20x0.94	19.84	3.31	5.20	4.41	0.91	13.39
2000	1	74.96	0.24x0.71	0.20x0.94	26.46	3.75	6.14	5.28	1.06	15.35
3000	1	83.77	0.31x0.94	0.20x0.94	41.89	5.07	7.72	5.91	1.22	18.50
4000	2	79.37	0.24x0.71	0.20x0.94	39.68	5.51	6.14	5.28	1.38	20.87
4000	1	88.18	0.31x0.94	0.20x0.94	44.09	5.07	9.02	6.10	1.38	23.82
6000	2	92.59	0.31x0.94	0.20x0.94	61.73	8.16	7.72	5.91	1.54	24.80
10.000	2	99.21	0.39x1.18	0.20x0.94	90.39	11.68	9.02	6.73	1.77	28.74
20.0001	4	103.62	0.39x1.18	0.20x0.94	174.16	21.38	15.55	6.73	2.24	36.22
40.000*	8	110.23	0.39x1.18	0.20x0.94	392.42	42.77	25.28	7.87	2.95	41.34

* Model available on special order

** Weight of load chain and han chain

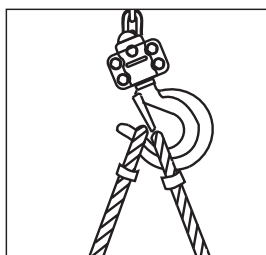

Incorrect set up
Dangerous

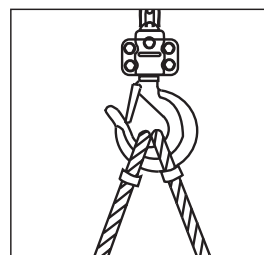

Correct set up



1) INTRODUCTION

The tralift® is a portable manual chain hoist for lifting loads that is normally used on a fixed anchor point or with suspension trolleys. Information about suspension trolleys can be obtained from TRACTEL INC./LTD. by request.

The tralift® uses a double spur gear mechanism that is designed to provide optimum working efficiency. It is also lightweight and requires limited headroom.

tralift® is supplied with a standard 10-foot (3 m) lift of ISO grade 80 minimum load chain (except fi ton with grade 60 minimum load chain). The hand chain supplied with all models is 5x24 mm. An optional load-limiting device is available as well as a special corrosion resistant chain. Additional information can be obtained from TRACTEL INC./LTD. by request.

A serial number is engraved on the label of every hoist (see Figure 18, page 27). Please refer to this number whenever inquiries are made regarding your hoist or parts for it.

1 - Fall Model

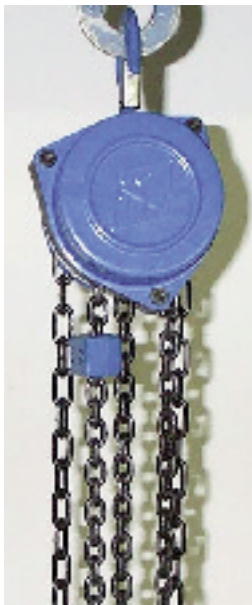

Figure 1

1/2, 1, 1^{1/2}, 2 ton

2 - Fall Model



Figure 2

3, 5 ton

4 - Fall Model

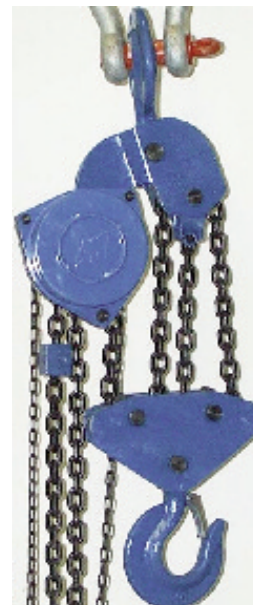

Figure 3

10 ton

Maximum Capacity (tons)	1/2	1	1 ^{1/2}	2	3	5	10	20 (not shown)
Code #	19709	19719	19729	19739	19749	19759	19769	19779
Number of Falls	1	1	1	1	2	2	4	8
Load Chain (mm)	5x15	6x18	8x24	8x24	8x24	10x30	10x30	10x30
Shipping Wt (w/ standard lift)	20 lbs.	27 lbs.	42 lbs.	40 lbs.	62 lbs.	90 lbs.	174 lbs.	393 lbs.
	9 kg	12 kg	19 kg	18 kg	28 kg	41 kg	79 kg	178 kg

Table 1



2) INSTALLATION

Before installing the tralift® make the following checks:

- 2.1. Check that the hoist is in good condition.
- 2.2. Check that the correct capacity hoist is to be used.
- 2.3. When using a hoist with 2 or more falls of load chain ensure that there is no twisting.
- 2.4. Check that the load chain is correctly fitted with the link welds on the outside of the load sheave especially when lifts other than the standard 3 metres are used.
- 2.5. Check that the anchor point is sufficient to take the intended load.

Once these checks have been carried out and the hoist is installed on its anchor point the following procedure should be carried out before any work commences :

- 2.6. Check that the hoist is correctly attached to the anchor point and the top hook safety catch is closed.
- 2.7. Check that the load chain has not become twisted during installation.
- 2.8. Without load check that the up and down functions operate correctly.
- 2.9. When using the hoist with a push suspension trolley, without load, check that the trolley moves freely. If using a geared suspension trolley, without load, check the direction of movement by pulling on the trolley hand chain.



The user should check that :

- **The hooks and catches are in good condition.**
- **The anchoring accessory of the load seats fully in the hook and does not prevent the catch from closing (see illustration).**
- **The load on the hoist is free to align itself with the machine's anchor point.**

3) OPERATION

The tralift® chain hoist is operated by means of a hand chain which is pulled by the operator to lift or lower a suspended load.

With the handwheel casing facing towards the operator the following procedure actions lifting and lowering:

3.1. To lift pull the right hand chain.

3.2. To lower pull the left hand chain.

It is not recommended to pull the hand chain at excessive speed as this will lead to an uneven movement of the load. It is recommended to pull the hand chain in a steady movement to prevent any unnecessary jerking of the load.

4) INSPECTION

4.1 Service Schedule

To ensure safe and satisfactory operation, authorized and trained technicians who can recognize worn and hazardous parts must regularly inspect the hoist. Required intervals of inspection are reliant on the individual application of the hoist and are dependent on many factors. Inspection schedules vary taking into consideration the loads lifted, working conditions (including dust, moisture, temperature, etc.) and any other factors that may deteriorate or damage the machinery. Following is a recommended maintenance schedule.

	Inspection Schedule		
	Service	Frequent	Periodic
Normal	Monthly	Quarterly	
Heavy	Weekly	Monthly	
Severe	Daily	Weekly	

Table 2

4.2 Frequent Inspection

For normal operation, the tralift® should be inspected at the beginning of each month as well as throughout any operation for the following items. If any deficiencies are noticed, the hoist must immediately be removed from operation until serviced by an authorized technician.

- 1) **Operation** - Check for visual or audible signs that may indicate a potential problem. Operate the hand chain and notice the distinctive "clicking" sound as well as the smoothness of operation. Pay attention to the movement of each chain and be certain the load chain stops moving at the same time as the hand chain.
- 2) **Hooks** - Visually check for any signs of wear or damage including increased throat width, bent shanks, twisted hooks, cracking or any other defects.

Check latches for proper operation. See page 9, section 5 for a description of how to look for damage.

- 3) **Chain** - Ensure there is no twisting in any section of any chain.

- 4) **Lubrication** - The entire load chain should be lubricated each week for extended longevity. For severe or corrosive conditions more frequent lubrication may be necessary. **SAE 50 to 90 EP oil is recommended.** The same lubricant should be applied to the hook and latch. Rust and abrasives may be removed by using an acid free solvent followed by a thorough lubrication.



**DO NOT USE CAUSTIC ACID
TO CLEAN CHAIN.**

4.3 Periodic Inspection

For normal service it is recommended that the tralift® be thoroughly inspected quarterly. Written records should be kept on all periodic inspections to ensure continual evaluations of the hoists. A qualified technician must perform these inspections.

- 1) **INSPECTION OF ALL ITEMS LISTED BELOW REQUIRE FREQUENT INSPECTION**
- 2) **Load Block** - Inspect for any evidence of wear, damage, sharp edges, deformation or contaminants. Ensure that both chains travel properly through the hoist without incident. If any problems are noticed, disassemble the unit and further inspect all gears, shafts, bearings, sheaves, chain parts, springs and covers. Replace or repair any component(s) as necessary.



3) Brake - Inspect for proper operation, ensuring the brake does not slip while holding a load. The hoist shall be capable of lifting 125% of the rated load without any movement when the hand chain is released. Check all surfaces for oil, wear, deformation, cracks or foreign objects. If any defects are noticed, disassemble and repair or replace parts as needed (see page 17).

4) Chain Sheaves - Inspect for damage or excessive wear that may affect hoist operation.

5) Hooks- Inspect both hooks for the following conditions:

- a) The hooks should rotate freely even when under load.
- b) Latches should be appropriately secured in place and open/close properly.
- c) Any signs of cracking (use of magnetic particle or dye penetrants are recommended).
- d) Any indications of deformation including:

i) *Throat Width*

- (1) New style hooks (see Figure 12, page 16) have elongation marks that are measured by comparing the distances between pins 1 and 2 and pins 1 and 3. The difference between these distances should be no more than 5 mm as shown in Figure 4.

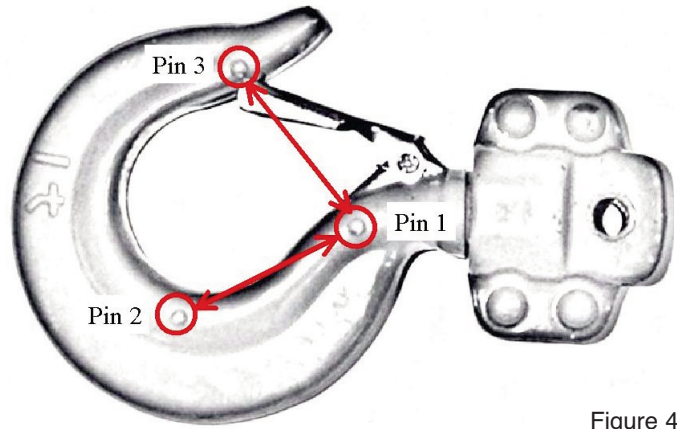

Figure 4

- ii) *Twisting* - Check for twisting of the hook (Figure 5). Discard if twisted over 10°.

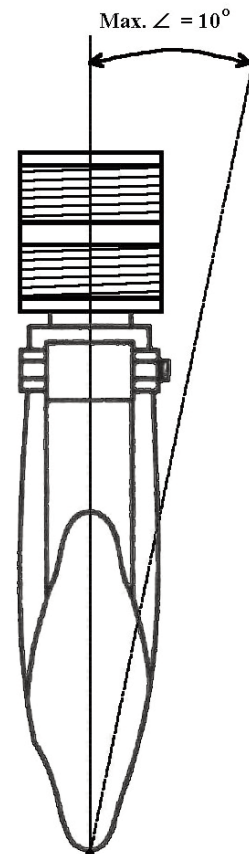

Figure 5



NOTE: See page 18 for serial numbers of new style hoists

WARNING

AFTER AN INTENSIVE PERIOD OF USE, THE CHAIN MAY SHOW SIGNS OF ELONGATION OR WEAR WHICH COULD DAMAGE THE HOIST OR CAUSE THE CHAIN TO BREAK. IT IS THEREFORE RECOMMENDED THAT THE LIFTING CHAIN IS INSPECTED REGULARLY (Refer to Table 2). THE CHAIN SHOULD BE MEASURED AND MUST BE REPLACED IF THE MEASUREMENTS ARE GREATER THAN THOSE GIVEN IN THE FOLLOWING TABLE.

In this case, it is also recommended that the wear of the chain guide and the load sprocket wheel is checked at an approved service shop.

For taking measurements the chain must be cleaned with a solvent which is neither acid nor caustic (use a white spirit type solvent).

In addition, when each link on a total length of 11 links Figure 6 has been examined, the chain must be replaced if any of the following is found:

- Corroded or cracked links.
- Distorted or twisted links.
- Stretched or particularly worn links.

Do not expose the chain to temperatures greater than 100° C or to attack from mechanical or chemical agents.

Lightly oil the load chain regularly with SAE 120 type oil or equivalent.

CAUTION

Lubricants must be handled and disposed of according to local, state and federal regulations.



NOTE : Systematically or repeatedly stopping and starting at the same place will cause more rapid wear of the links which stop on the load sprocket wheel. If the chain needs to be replaced, this must be performed by a **TRACTEL** approved service shop.

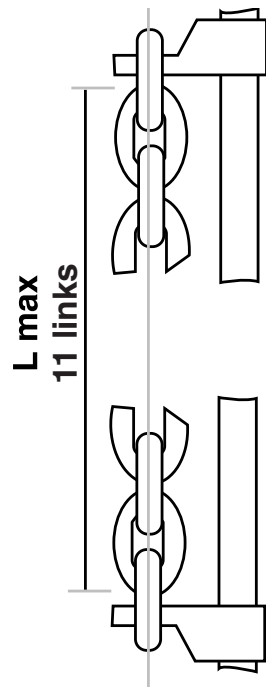

Figure 6

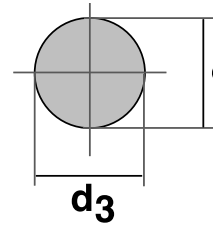

Figure 7

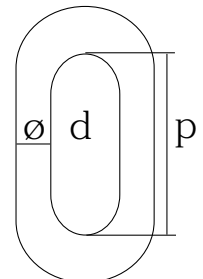

Figure 8

Rated Load (ton)	Number of falls of chain	Loaded chain x pitch (mm)	Diameter, d (Figure 8)		Pitch, p (Figure 8)		Max. L permitted length for 11 links (Figure 6)		Max wear on 1 link p 5%		Reject if $d_m < 0.9d$		Reject if $d_5 < 1.8d$	
			inches	mm	inches	mm	inches	mm	inches	mm	inches	mm	inches	mm
1/2	1	5x15	0.197	5.0	0.591	15.0	6.634	168.5	0.620	15.75	0.177	4.5	0.354	9.0
1	1	6x18	0.236	6.0	0.708	18.0	7.800	198.0	0.744	18.90	0.213	5.4	0.425	10.8
1 1/2	1													
2	1	8x24	0.315	8.0	0.945	24.0	10.610	269.5	0.992	25.20	0.283	7.2	0.567	14.4
3	1	8x24	0.315	8.0	0.945	24.0	10.610	269.5	0.992	25.20	0.283	7.2	0.567	14.4
5	2	10x30	0.393	10.0	1.180	30.0	12.990	330.0	1.240	31.50	0.354	9.0	0.709	18.0
10	4	10x30	0.393	10.0	1.180	30.0	12.990	330.0	1.240	31.50	0.354	9.0	0.709	18.0
20	8	10x30	0.393	10.0	1.180	30.0	12.990	330.0	1.240	31.50	0.354	9.0	0.709	18.0

Table 3

Check the wear at the articulation point:

d_m = average diameter after wear.

d_5 = sum of two links diameter together.

d_3/d_4 : refer to Figure 7.

$$d_m = \frac{d_3 + d_4}{2} < 0.9 d$$

7) Hand Chain - Inspection of the hand chain involves the following tests:

- a) There should be no twists throughout the entire length.
- b) Welds should be directed away from the handwheel pocket.
- c) Check each link for bending, pitting, weld cracks, gouging or any other irregularities.
- d) If a "C-Link" is being used, ensure it is closed properly.

If any of these conditions are not met, replace the entire chain before further use.

8) Fasteners - Check that all rivets, screws, nuts, cotter pins and any other fasteners belonging on the hoist are in place and are in good condition.

9) Labels and Tags - Check for legibility and presence (see page 27). Replace the labels and tags if necessary.

10) Supporting Structure - Inspect all supports for deformations or wear which may affect the ability to support further loading.

4.4 Lubrication

If possible or unless stated otherwise, always attempt to replace old lubricant before reassembly of any components with a new coating of lubrication. Use of thread lubricant or anti-seize compound is recommended for threaded shafts. For gears, use of EP 1 grease is recommended for temperatures in the range of -20 to 50 F (-29° to 10° C). EP 2 grease is recommended for temperatures between 30° to 120° F (-1° to 49° C). The chain should be lubricated with SAE 50 to 90 EP oil.



DO NOT USE CAUSTIC ACID TO CLEAN CHAIN.



4.5 Testing

After any installation or repair, testing should be performed to ensure smooth operation and proper brake function. To test the hoist, first lift a light load and then carefully lift 125% of the rated load a few inches from the floor. Be sure the brake holds the loads in both tests securely before further lifting. No movement of the hook should occur for any load within the rated hoist capacity. Any testing should be performed by qualified persons and documented in writing. Refer to ASME B30.16 and HST-2M as well as other pertinent federal, state, and local regulations.

5) MAINTENANCE

5.1 Removing the Handwheel Cover

- a) If a load is attached to the hoist, it shall be removed.
- b) Signs and barriers shall be used on the floor beneath the hoist where overhead maintenance work creates a hazard.

Remove the handwheel cover by removing the following items from the three bolts on the cover:

- >> 3 12mm nuts
- >> 3 Locking washers (see Figure 9)
- >> 3 Flat washers

Figure 9

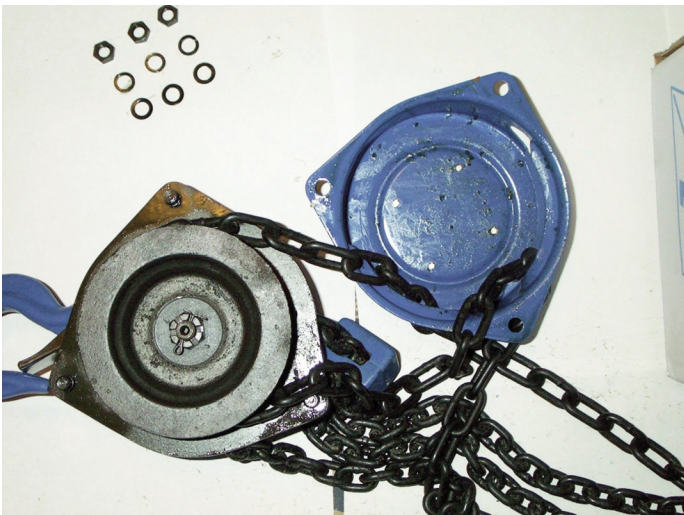

5.2 Installing the New Hand Chain

- 1) Remove the old hand chain, if necessary, by cutting or bending the "C-link" (see Figure 10).
- 2) Cut a new hand chain to the correct length. The length of chain needed is equal to double the height of lift required. If desired, subtract approximately 4 feet to keep the hand chain from touching the floor during operation.
- 3) Remove the handwheel cover as described above.
- 4) Insert the first few links of the new chain into the handwheel, being sure to direct the welds away from the handwheel.
- 5) Turn the handwheel until the chain begins to emerge.
- 6) Check to be sure the links on the hand wheel are correctly placed (welds directed away from the handwheel).
- 7) Reinstall the handwheel cover.
- 8) Pull on the chain until a few feet are available.
- 9) Connect both ends of the new hand chain using a "C-link".
- 10) Close the "C-link" properly using a vise and pliers.

5.3 Installing New Load Chain

- 1) Remove old load chain if necessary (the chain can be cut if desired).
 - a) Load chains and hand chains should be kept clean and free from any coating or deposit that will build up and change their dimensions or reduce flexibility. The cleaning process shall not damage these chains and any solution used in the cleaning process shall be acid free.

To remove chain from the chain shaft (dead end):

- i) Remove either cotter pin from the chain shaft (page 20 to page 26).
- ii) Slide the shaft out of the way.
- iii) Remove the chain; cut old load chain into small lengths and discard appropriately.

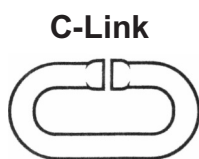

Figure 10



For hoists with more than one fall:

- b) Load chains articulate slowly under high bearing pressures and should be lubricated as specified by the hoist manufacturer. Hand chains are light loaded and normally need little or lubrication; however, the hoist manual should be reviewed for specific lubrication information.

To remove chain from the suspension plate (dead end):

- i) Remove the nut and bolt from the suspension plate (page 20 to page 26).
 - ii) Remove the chain and dispose of properly.
- 2) Cut a new load chain to the correct length. The length of chain required is equal to the desired lift times the number of falls the hoist requires.

- 3) Remove the handwheel cover as described on page 14.
- 4) Attach approximately 2 feet (1 m) of soft wire to one end of the new load chain.
- 5) Insert the wire into the entry side of the hoist, over the load sprocket, and through the inside of the guide roller.
- 6) Position the load chain so the welds are directed away from the chain sprocket.
- 7) Remove the wire and pull the hand chain in the hoisting direction until about 6 inches (15 cm) of load chain have emerged.
- 8) Continue turning the handwheel clockwise until only a couple of feet (1 m) of load chain are left on the dead end.
- 9) While avoiding any twisting, secure the dead end of the chain to the chain shaft or suspension plate by:
 - a) Removing the cotter pin.
 - b) Slide the shaft out of the way.
 - c) Insert the last link of chain.
 - d) Slide the shaft through the last link.
 - e) Replace cotter pin.
- 10) Install the chain stop approximately 3 links from the dead end (new style hoists have a fixed chain stop).
- 11) Turn the handwheel counterclockwise until a couple of feet (1 m) of the dead end are available.
- 12) Install the hook **as described in the following section.**
- 13) Continue to turn the handwheel counter clockwise until the hook is almost completely hoisted.
- 14) Check for any twisting of the chain.
- 15) Ensure that the pawls on the side plate (under the handwheel) are engaged correctly (see Figure 16 on page 17).
- 16) Restall the handwheel cover.

5.4 Installing a New Load Hook

1) For models with one fall:

For new style hooks (see Figure 12):

- i) Insert the last link into the hook swivel.
- ii) Secure with 10 mm bolt and nyloc nut supplied with hook.



Figure 10

2) For models with two falls (see Figure 13):



NOTE:

See page 19 for serial numbers of new style hoists.

- a) While avoiding twisting, pass the dead end of chain through the idle sheave on the bottom block (page 20 to page 26).
 - b) Secure the dead end to the suspension plate with bolt through the last link of chain.
- ### 3) For the model with four falls, perform the following while avoiding twisting of the chain (Figure 12):
- a) Pass the end through the first idle sheave on the bottom hook block (page 20 & 26).

- b) Pass the end over the idle sheave on the top hook block (page 20 to page 26).

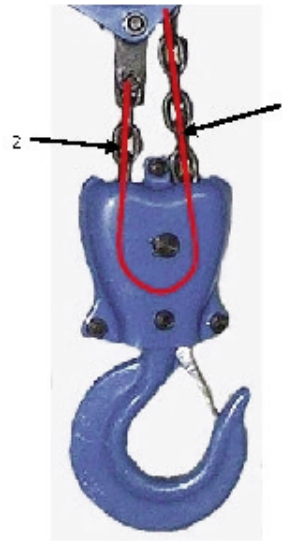

Figure 11

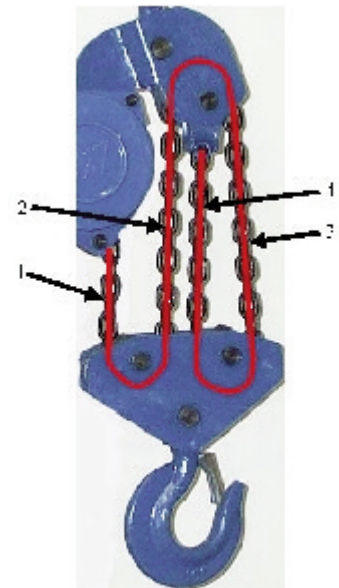

Figure 12

- c) Pass the end through the second idle sheave on the bottom hook block.
- d) Secure the dead end to the suspension plate with bolt through the last link of chain.



Twisting of the load chain can cause jamming internally and cause the chain to break. Also, the load chain must be reeved properly to prevent the chain from coming off the load sheave. Either of these conditions may allow the load to drop.

5.5 Brake Replacement

- 1) Remove the handwheel cover as described on page 17.
- 2) Remove the cotter pin from the 17 mm nut.
- 3) Turn the 17 mm nut counterclockwise to remove. Note that the nut is not tight!
- 4) Remove the hand chain from the handwheel.
- 5) Turn the handwheel counterclockwise to remove.
- 6) Remove and inspect/replace the ratchet wheel and both friction disks (see Figures 13 and 14).
- 7) Reverse procedure to install.

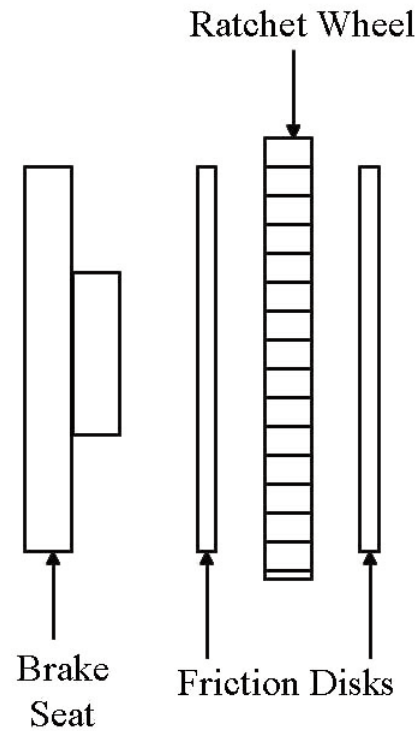

Figure 13



THE BRAKE ASSEMBLY MUST BE FREE OF OIL AND FOREIGN OBJECTS TO ENSURE SAFE OPERATION.

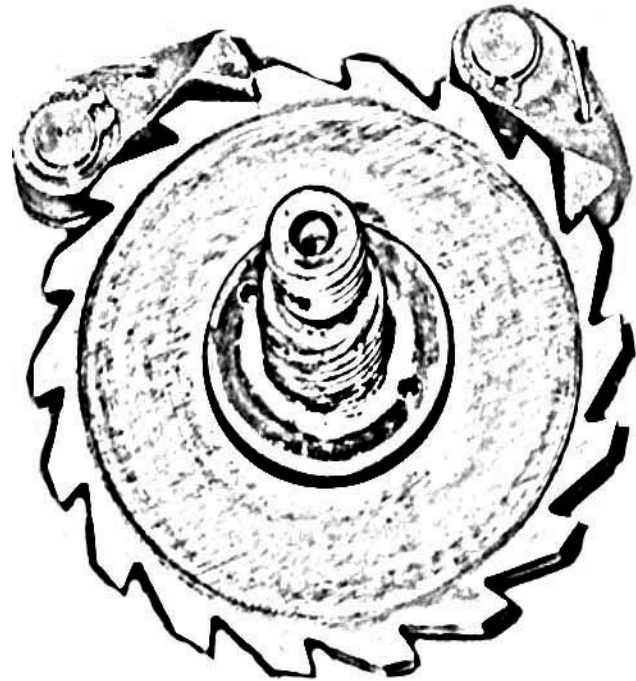

Figure 14

6) TROUBLESHOOTING

tralift® chain hoists are designed to be trouble-free when operated properly and routinely maintained. However, from time to time certain problems may arise from unforeseen reasons. Qualified technicians best identify the causes of these troubles. The following list should provide answers to the most common problems associated with this product.

PROBLEM	POSSIBLE CAUSES	COMMON REMEDIES
Hoist does not lift a load.	Hoist is overloaded.	Reduce load until within the rated load of the hoist.
Load does not stop immediately when hand chain stops.	Hoist is overloaded. Brake is slipping.	Reduce load until within the rated load of the hoist. Check for oil or wear on the friction plates and brake adjustment.
Load chain binds.	Damage to one of the following: Load chain Chain sprocket (load sheave) Driving shaft Gears Twisted load chain	Inspect and replace as necessary.
Hand chain binds	Damage to one of the following: Load chain Chain sprocket (load sheave) Hand chain Handwheel Driving shaft Gears	Inspect and replace as necessary.
Latch on load hook does not open correctly or smoothly.	Broken/damaged latch Bent or twisted hook (page 9)	Replace the hook or latch as necessary.

7) REMOVAL FROM SERVICE & STORAGE

Table 4

When taking the hoist out of service, ensure that any load is placed safely and securely on the ground. Also make sure that the load chain is slack enough to enable the bottom hook to be removed from the load.

It is recommended that the hoist be stored hanging so that the load chain does not become tangled. Store the hoist in a dry and weatherproof area. Before storage the load chain should be cleaned with a soft brush and lubricated with machine oil (see page 10 to page 13).

Any hoist that has not been used within a period of one year must be checked as required by the before outlined Periodic Inspection. All hoists that have been idle for a period less than one year should be examined as previously outlined in the section titled Frequent Inspection. Standby hoists must always be in operable conditions and therefore should be inspected on the same interval as a hoist in service. For hoists subjected to abnormal conditions, these requirements should be adjusted accordingly.

8) PRODUCT IMPROVEMENTS

New hooks, chain stops and anchor points have been supplied on hoists beginning with the following serial numbers. Hoists that have serial numbers with an "A" prefix have the newest improvement of sealed drive shaft bearings.

Rated Load (ton)	1/2	1	1 ^{1/2}	2	3	5	10	20
Serial #	008541	004799	008481	004879	008521	008536	014320	006720

Table 5



9) TECHNICAL DATA

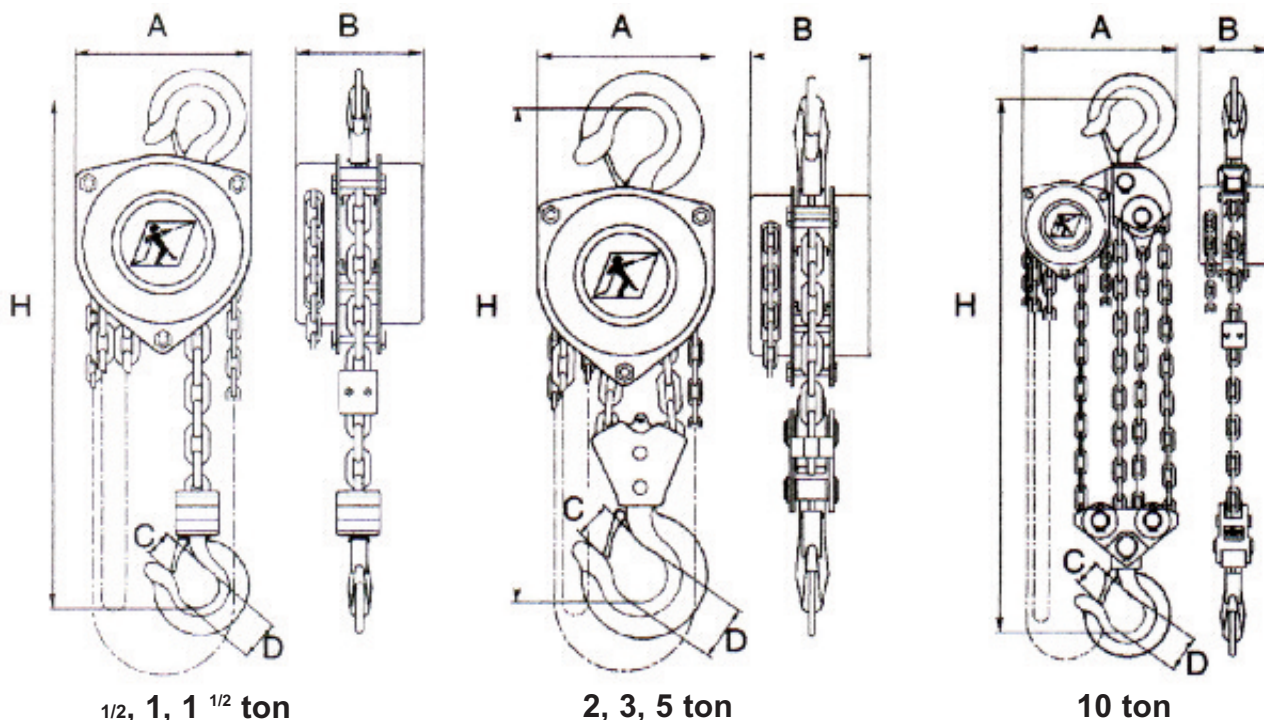

Item #	Rated Load		Number of Falls	Effort for Rated Load		Load Chain mm	Weight of Chain	
	tons	kg		lbs.	kg		lbs./ft	kg/m
19709	1/2	500	1	46	21	5x15	1.0	1.5
19719	1	1000	1	77	35	6x18	1.2	1.8
19729	1 1/2	1500	1	86	39	8x24	1.5	2.3
19739	2	2000	2	77	35	6x18	1.8	2.7
19749	3	3000	2	86	39	8x24	2.5	3.4
19759	5	5000	2	93	42	10x30	3.6	5.3
19769	10	10000	4	99	45	10x30	6.5	9.7
19779	20*	20000	8	99	45	10x30	13.0	19.4

Table 6
* not shown

Item #	Rated Load		Dimensions								Weight of Hoist w/chain (10' of lift)	
			A		B		C		H _{min}			
	tons	kg	inches	mm	inches	mm	inches	mm	inches	mm	lbs.	kg
19709	1/2	500	5.2	132	4.4	112	0.9	23	13.4	340	20	9
19719	1	1000	6.1	156	5.3	134	1.1	27	15.4	390	27	12
19729	1 1/2	1500	7.7	196	5.9	150	1.2	31	18.5	470	42	19
19739	2	2000	6.1	156	5.3	134	1.4	35	20.9	530	40	18
19749	3	3000	7.7	196	6.1	150	1.5	39	24.8	630	62	28
19759	5	5000	9.0	229	6.7	171	1.8	45	28.7	730	90	41
19769	10	10000	15.6	395	6.7	171	2.2	57	36.2	920	174	79
19779	20*	20000	25.3	642	7.9	200	3.0	75	41.3	1.5	393	178

Table 7

- Item #'s shown are for standard machines with 10 ft. (3m) of lift, but are available up to 40 ft (12m).
- Load limiter is an available option.



9.1 New Style - Exploded View



NOTE:
See page 21 for serial numbers
of new style hoists.

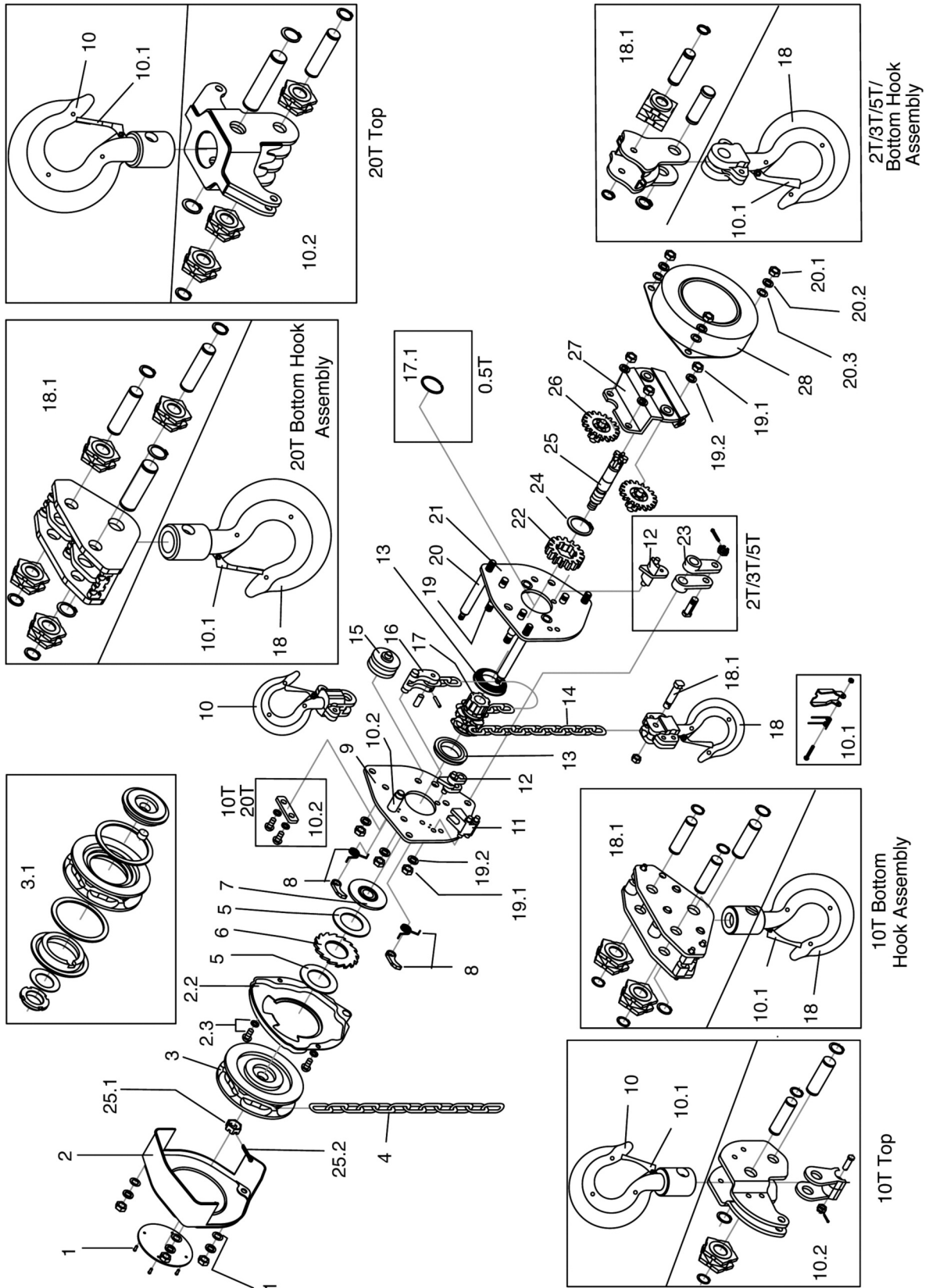

9.2 New Style - Spare Parts List



Pos. No.	Description	Qty	0.5t Code No.	1t Code No.	1.5t Code No.	2t Code No.	2t 1/1 Code No.	3t Code No.	5t Code No.	10t Code No.	20t Code No.
Label kit			3932	4222	4522	4682	18202	4882	5232	5412	18362
1	Label & rivets	1									

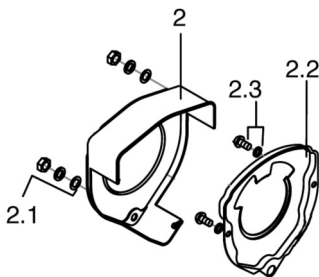

Pos. No.	Description	Qty	0.5t Code No.	1t Code No.	1.5t Code No.	2t Code No.	2t 1/1 Code No.	3t Code No.	5t Code No.	10t Code No.	20t Code No.
Hand wheel cover kit			34002	34012	34022	34012	34032	34022	34042	34042	34042
2	Hand wheel cover	1									
2.1	Nuts & washers	3									
2.2	Brake cover	3									
2.3	Screws & washers	2									



Pos. No.	Description	Qty	0.5t Code No.	1t Code No.	1.5t Code No.	2t Code No.	2t 1/1 Code No.	3t Code No.	5t Code No.	10t Code No.	20t Code No.
Hand wheel kit			6242	6252	34052	6252	18912	34052	34062	34062	34062
Unit Price											
3	Hand wheel	1									

9.3 New Style - Spare Parts List

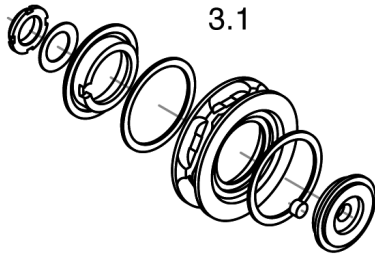

			0.5t	1t	1.5t	2t	2t 1/1	3t	5t	10t	20t
Pos. No.	Description	Qty	Code	Code	Code	Code	Code	Code	Code	Code	Code
			No.	No.	No.	No.	No.	No.	No.	No.	No.
Load limiter kit			6262	6272	34142	6272	34142	34142	34152	34152	34152
3.1	Load limiter	1									

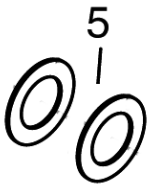

			0.5t	1t	1.5t	2t	2t 1/1	3t	5t	10t	20t
Pos. No.	Description	Qty	Code	Code	Code	Code	Code	Code	Code	Code	Code
			No.	No.	No.	No.	No.	No.	No.	No.	No.
Brake disc kit			3862	4162	34072	4162	4462	34072	5162	5162	5162
Unit Price											
5	Brake discs	2									

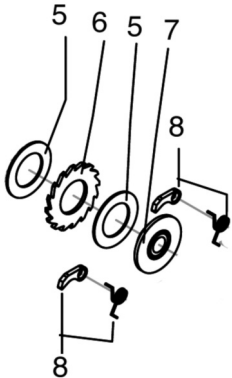

			0.5t	1t	1.5t	2t	2t 1/1	3t	5t	10t	20t
Pos. No.	Description	Qty	Code	Code	Code	Code	Code	Code	Code	Code	Code
			No.	No.	No.	No.	No.	No.	No.	No.	No.
Brake kit			22042	22052	34082	22052	18932	34082	22072	22072	22072
5	Brake discs	2									
6	Ratchet wheel	1									
7	Brake seat	1									
8	Pawl & spring	2									



9.4 New Style - Spare Parts List

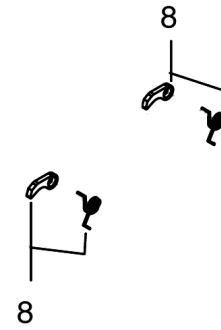
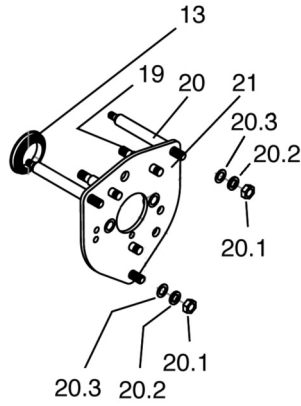
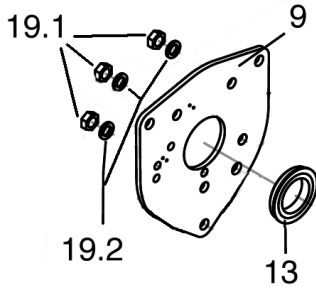

			0.5t	1t	1.5t	2t	2t 1/1	3t	5t	10t	20t
Pos. No.	Description	Qty	Code	Code	Code	Code	Code	Code	Code	Code	Code
			No.	No.	No.	No.	No.	No.	No.	No.	No.
Side plate kit			34092	34102	34112	51272	34122	51282	34132	34132	34132
8	Pawl & spring	2									
9	Side plate	1									
13	Bearing	2									
19	Inner stay bolt	3									
19.1	Nut	3									
19.2	Washer	3									
20	Outer stay bolt	3									
20.1	Nut	3									
20.2	Spring washer	3									
20.3	Washer	3									
21	Side plate	1									

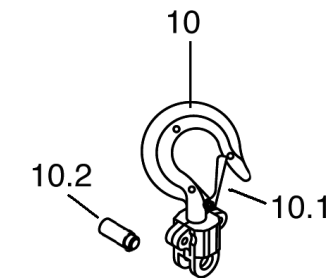

10t top hook

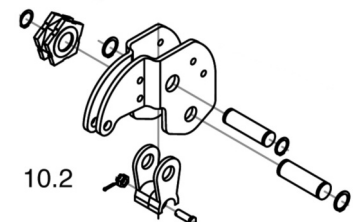
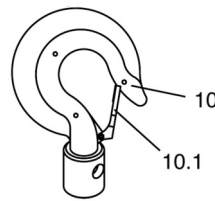

10.3 - 10t top hook block

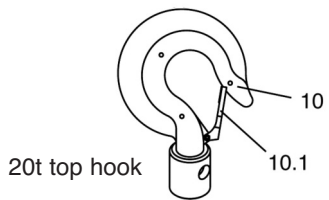

20t top hook

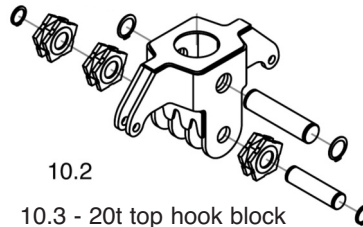

10.3 - 20t top hook block



10.4 - 10t & 20t top hook plate

			0.5t	1t	1.5t	2t	2t 1/1	3t	5t	10t	20t
Pos. No.	Description	Qty	Code	Code	Code	Code	Code	Code	Code	Code	Code
			No.	No.	No.	No.	No.	No.	No.	No.	No.
Top hook assembly			22122	22132	22142	22152	22162	22172	22182	22192	22202
10	Top hook	1									
10.1	Safety catch	1									
10.2	Top hook pin	1									
10.3	Top hook block	1									
10.4	Top hook plate	1									



9.5 New Style - Spare Parts List

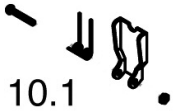

			0.5t	1t	1.5t	2t	2t 1/1	3t	5t	10t	20t
Pos. No.	Description	Qty	Code	Code	Code	Code	Code	Code	Code	Code	Code
			No.	No.	No.	No.	No.	No.	No.	No.	No.
Safety catch kit			8902	8912	8922	8932	18262	8942	8952	8962	18382
10.1	Safety catch	1									

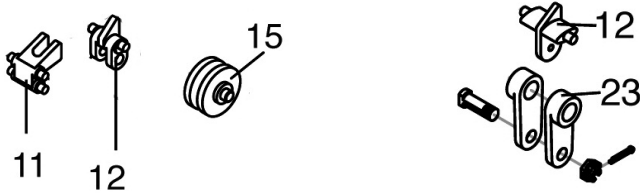

			0.5t	1t	1.5t	2t	2t 1/1	3t	5t	10t	20t
Pos. No.	Description	Qty	Code	Code	Code	Code	Code	Code	Code	Code	Code
			No.	No.	No.	No.	No.	No.	No.	No.	No.
Chain guide kit			22212	22222	22232	18972	22232	18952	22242	22242	22242
11	Upper chain guide	1									
12	Chain stripper	1									
15	Guide roller	1									
23	Chain anchor	1									



			0.5t	1t	1.5t	2t	2t 1/1	3t	5t	10t	20t
Pos. No.	Description	Qty	Code	Code	Code	Code	Code	Code	Code	Code	Code
			No.	No.	No.	No.	No.	No.	No.	No.	No.
Bearing kit			22252	22262	22272	22262	22272	22272	22282	22282	22282
13	Bearing	2									

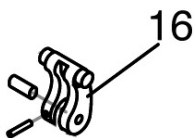

			0.5t	1t	1.5t	2t	2t 1/1	3t	5t	10t	20t
Pos. No.	Description	Qty	Code	Code	Code	Code	Code	Code	Code	Code	Code
			No.	No.	No.	No.	No.	No.	No.	No.	No.
Chain stop kit			9122	9132	9142	9132	9142	9142	9152	9152	9152
16	Chain stop	1									



9.6 New Style - Spare Parts List

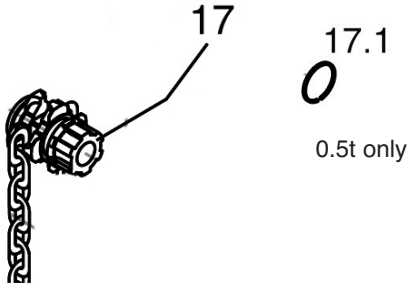

17.1
0
0.5t only

			0.5t	1t	1.5t	2t	2t 1/1	3t	5t	10t	20t
Pos. No.	Description	Qty	Code	Code	Code	Code	Code	Code	Code	Code	Code
			No.	No.	No.	No.	No.	No.	No.	No.	No.
Chain sprocket kit			8752	8762	8772	8762	8772	8772	8782	8782	8782
17	Chain sprocket	1									
17.1	Retaining ring (0.5t)	1									

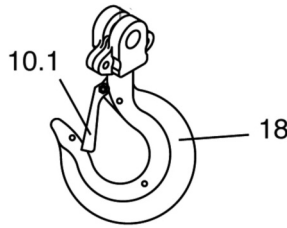
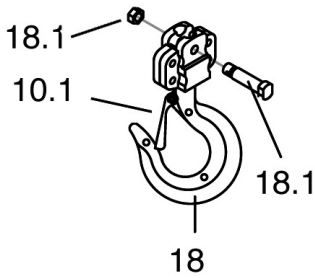

2t, 3t, & 5t bottom hook

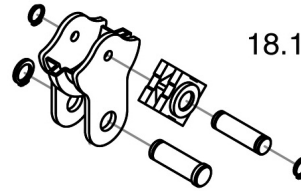

18.2 - 2t 3t & 5t boittom hook block

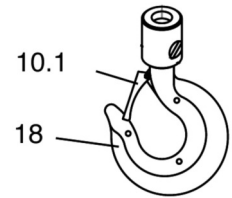

10t bottom hook

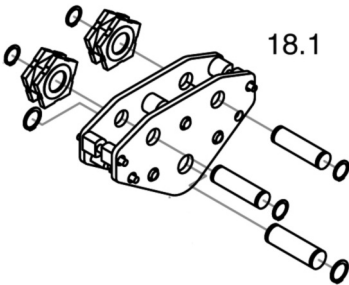

18.2 -10t bottom hook block

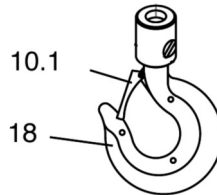

20t bottom hook

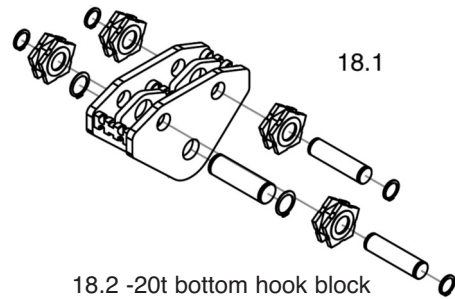

18.2 -20t bottom hook block

			0.5t	1t	1.5t	2t	2t 1/1	3t	5t	10t	20t
Pos. No.	Description	Qty	Code	Code	Code	Code	Code	Code	Code	Code	Code
			No.	No.	No.	No.	No.	No.	No.	No.	No.
Bottom hook assembly			22292	22302	22312	22322	22332	22342	22352	22362	22372
18	Bottom hook	1									
10.1	Safety catch	1									
18.1	Bottom hook pin	1									
18.2	Bottom hook block	1									



9.7 New Style - Spare Parts List

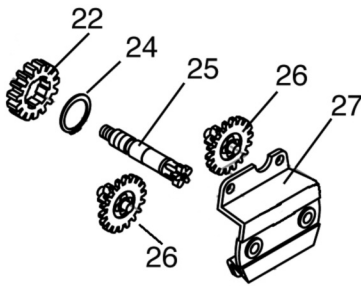

			0.5t	1t	1.5t	2t	2t 1/1	3t	5t	10t	20t
Pos. No.	Description	Qty	Code	Code	Code	Code	Code	Code	Code	Code	Code
			No.	No.	No.	No.	No.	No.	No.	No.	No.
Gear kit			22382	22392	22402	22392	18962	22402	22412	22412	22412
22	Main gear	1									
24	Snap ring	1									
25	Drive shaft	1									
25.1	Nut	1									
25.2	Pin	1									
26	Satellite gears	2									
27	Gear plate	1									

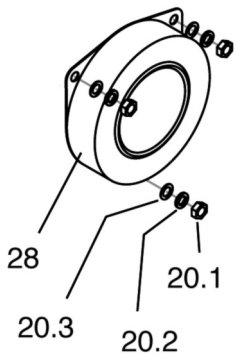

			0.5t	1t	1.5t	2t	2t 1/1	3t	5t	10t	20t
Pos. No.	Description	Qty	Code	Code	Code	Code	Code	Code	Code	Code	Code
			No.	No.	No.	No.	No.	No.	No.	No.	No.
Side cover kit			22422	22432	22442	22432	22442	22442	22452	22452	22452
28	Side cover	1									
20.1	Nut	3									
20.2	Spring washer	3									
20.3	washer	3									

10) LABELS & TAGS

Usually located on hoist box

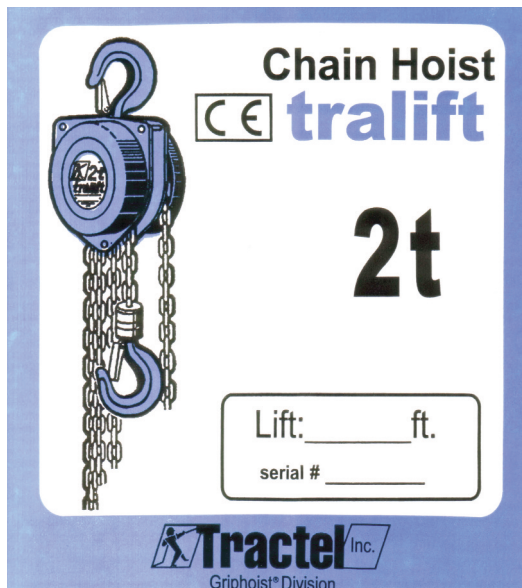

Not remove or obscure the safety labels, plates or tags furnished on the hoist.

Figure 17

Located on handwheel cover



Figure 18

Located on handwheel cover

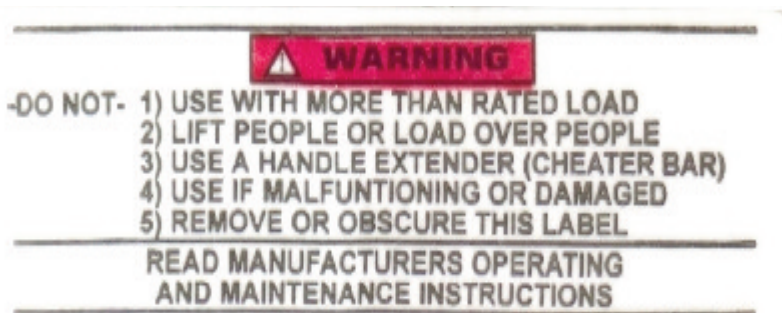

Figure 19



11) WARRANTY INFORMATION

- (1) Tractel® Inc for USA, Tractel® Ltd. for Canada warrants its equipment to be free from defects in material and workmanship under normal use and service.
- (2) Our obligation under this warranty is limited to repairing or replacing, at our option, any part of the unit, which proves examination to our satisfaction to be defective in material or workmanship, if the item in question is returned through a Tractel® distributor, transportation prepaid, within one (1) year from the equipment is sold to the original purchaser. Return shipment must be prepaid.
- (3) Any parts proved to be defective upon our inspection will be repaired or replaced at no cost for the parts themselves.
- (4) The obligation under this warranty does not include labor or travelling costs, or consequential damages of any kind.
- (5) Any defect in this equipment must immediately be brought to attention of the distributor from whom the unit was purchased. The distributor will make arrangements with the factory for repairs or replacement of parts within the terms of this warranty.

11.1 Parts Depot & Service

Replacement parts and service for trailift® material handling hoists are available from any of the following locations for customers in North America:



**Installation to be done by a Tractel®
trained repairer only!**

United States		Canada
<i>Boston</i>	<i>Los Angeles</i>	<i>Montreal</i>
51 Morgan Drive Norwood, MA 02062 Tel: 1.781.401.3288 Fax: 1.781.828.7600 1-800-421-0246	168 Mason Way – Unit B2 City of Industry, CA 91746 Tel: 1.626.937.6727 Fax: 1.626.937.6730 1-800-675-6727	11020 Mirabeau St. Anjou (Montreal) QUEBEC H1J 2S3 Phone: (514) 493-3332 Fax: (514) 493-3342 1-800-561-3229

Table 10

