

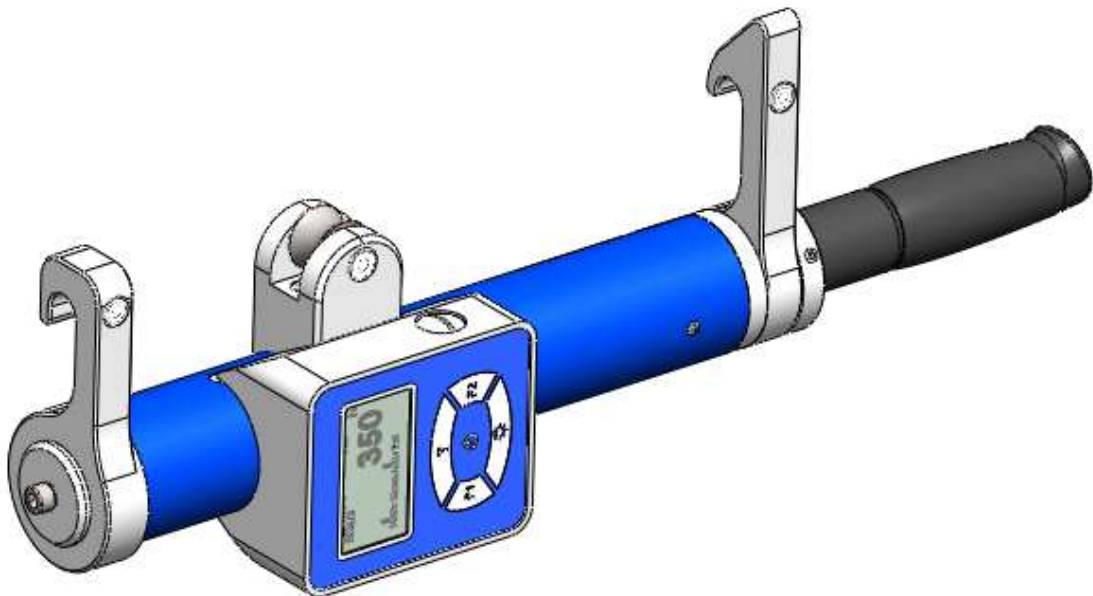

Tension meter dynaline HF45/LPT



EN



**Operation and
maintenance
manual**

SUMMARY

1.	DEFINITIONS	3
2.	PICTOGRAMS USED IN THIS MANUAL.....	3
3.	STANDARD CONTENT OF DELIVERY	3
4.	INTRODUCTION.....	4
4.1.	Description.....	4
4.2.	Characteristics	4
4.3.	Data bank HF 45/LPT	4
4.4.	Custom calibration	5
5.	PRESENTATION	6
5.1.	Tension meter HF 45/LPT.....	6
5.2.	Display information and keyboard functions	7
6.	TO CARRY A MEASUREMENT OUT	8
6.1.	To install the tension meter on the wire rope	8
7.	CONFIGURATION MENU	9
8.	ADVANCED FUNCTIONS.....	10
8.1.	Average	10
8.2.	Record	11
8.3.	Custom calibration	11
8.3.1	Create.....	11
8.3.2	Use	12
8.4.	Monitor.....	12
9.	MAINTENANCE, CHECKING AND CLEANING	12
9.1.	Changing batteries.....	12
9.2.	Regulatory check	13
9.3.	Maintenance	13
10.	MESSAGES.....	13
10.1.	Information messages.....	13
10.2.	Error messages.....	14
11.	PRODUCT MARKINGS	14

PRIORITY INSTRUCTIONS

1. Before installing and using this unit, to ensure safe, efficient use of the unit, be sure you have read and fully understood the information and instructions given in this manual. A copy of this manual should be made available to every operator. Extra copies of this manual can be supplied on request.
2. Do not use the unit if any of the plates mounted on the unit are missing or if any of the information on the plates, as indicated at the end of the manual, are no longer legible. Identical plates will be supplied on request; these must be secured on the unit before it can be used again.
3. Make sure that all persons operating this unit know perfectly how to use it in a safe way, in observance of all safety at work regulations. This manual must be made available to all users.
4. The positioning and commissioning of this appliance must be carried out under conditions that ensure installer safety in compliance with the relevant regulations.
5. Each time, before using the unit, inspect the unit for any visible damage, as well as the accessories used with the unit. Never use an appliance that is not obviously in good condition. Returns the appliance to the manufacturer for servicing if any anomalies arise that have no connection with the state of the battery;
6. Protect your appliance from any form of impact, especially the display unit.
7. The unit must never be used for any operations other than those described in this manual. The unit must never be used to handle any loads exceeding the maximum utilization load indicated on the unit. It must never be used in explosive atmospheres.
8. This appliance should never be used for man-riding applications without a thorough prior check that the utilization coefficients required for personnel safety have been applied, and more generally that the safety regulations for the load line on which it has been installed have been applied.
9. Tractel® declines any responsibility for use of this unit in a setup configuration not described in this manual.
10. Tractel® declines any responsibility for the consequences of any changes made to the unit or removal of parts.
11. Tractel® declines any responsibility for the consequences resulting from disassembly of the unit in any way not described in this manual or repairs performed without Tractel® authorization, especially as concerns replacement of original parts by parts of another manufacturer.
12. If the unit is to be definitively removed from use, make sure the unit is discarded in a way which will prevent any possible use of the unit. All environment protection regulations must be observed.
13. Any operation of this appliance in conjunction with supplementary equipment relaying signals on an operating system must be preceded by a risk analysis related to the operating functions implemented, carried out by the system user or assembler, and all appropriate measures are taken as a consequence.
14. Certified in compliance with European regulations, this appliance should be checked for compliance with the regulations of any other country where it might be used, prior to being commissioned there.



As part of the continuous improvement of the quality of its products, TRACTEL® reserves the right to change, without notice, the characteristics of the products covered in this manual.

1. DEFINITIONS

In this manual, the following terms mean:

« Product » : Equipment element or assembly defined on the cover page, delivered complete in its standard version, or as one of the various models described.

« Installation » : Comprehensive set of operations required to place a complete product in a condition ready for commissioning (or connection to other components for commissioning), starting from the state in which the product has been delivered.

« User » : Person or department responsible for the management and safe use of the product described in the manual.

« Technician » : Qualified person in charge of the maintenance operations described and authorized to the user by the manual ; the technician is understood to be skilled and familiar with the product.

« Operator » : Person or department using the product in compliance with the purpose for which it is intended.

2. PICTOGRAMS USED IN THIS MANUAL



«DANGER»: Remarks intended to prevent fatal, serious or minor injury to personnel or damage to the environment.



«IMPORTANT»: Remarks intended to prevent a failure or damage to the product, but not directly endangering the life or health of the operator or any other person, or damage to the environment



You must read the user and maintenance manual.

3. STANDARD CONTENT OF DELIVERY

- A Tension meter dynaline HF 45 LPT including 3 AA batteries
- A USB key with the LOADER Light program and a USB-Mini USB connection cable
- A CE certificate & calibration certificate
- A user manual
- A rugged carrying box

4. INTRODUCTION

4.1. Description

This tension meter dynarope™ HF 45 LPT is an electronic load cell that has been designed to measure the effort applied in a wire rope without having to dismantle the installation.

The resulting signal generated by the sensor equipped with strain gauges is interpreted by a digital display controlled by a microprocessor.

The display of the program has a database that contains a list of cables. The user selects from the list the cable whose characteristics correspond to the one he wants to measure. (See details in § 4.4)

The display corrects the force information (raw effort) based on the characteristics of the cable to be measured. The measurement result is displayed on an LCD screen.

4.2. Characteristics

- Capacity : from 0 up to 600 daN
- Diameters : from 8 up to 12 mm
- Accuracy : +/- 2% of full scale
- T° of use : -5°C to + 50°C
- Protection : IP 65
- Size of the packaging HF 45/LPT : 550 x 380 x 220 mm
- Weight of the HF 45/LPT in its transport case : 6 kg
- Net weight of the HF 47/LPT : 2,2 kg
- Power supply : 3 "AA" alkaline cells

4.3. Data bank HF 45/LPT

The Standard data bank includes several items that are identified by a "Reference Number". Each reference corresponds to a calibration process carried out on a particular sample.

The measurement wire rope is deemed to have a minimum length of 8 m, and is assumed to be tensioned between a fixed end and a "flexible" end (e.g. an aerial mast) in order to render negligible the influence of placing the sensor on the cable. Placing the sensor on the wire rope causes a shorting of the wire rope by approximately 1,5 mm.

If the installation does not match the above description or if the cable you wish to measure does not appear in the list, we recommend that a custom calibration is carried out (see § 8.3) or that you order a specific calibration (see § 4.4).

Item	Ref. Calibration	Material	Structure	Nominal diameter (mm)	Nominal diameter (")	Nominal diameter (mil")	Range (daN)
1	6500	Steel	1 x 19	8	5/16	0,3122	50 - 600
2	6503	Steel	7 x 7	8	5/16	0,3150	50 - 600
3	6501	Steel	6 x 19	8	5/16	0,3150	50 - 600
4	6504	Steel	7 x 19	8	5/16	0,3150	50 - 600
5	6505	Steel	7 x 19	10	3/8	0,3937	50 - 600
6	6506	Steel	8 x 19	8	5/16	0,3150	50 - 600
7	6502	Steel	6 x 36	12		0,4724	50 - 600

4.4. Custom calibration

Others optional specific calibrations can be added on customer's request, for special wire rope a sample must be supplied (ask for the specific calibration form).

5. PRESENTATION

5.1. Tension meter HF 45/LPT

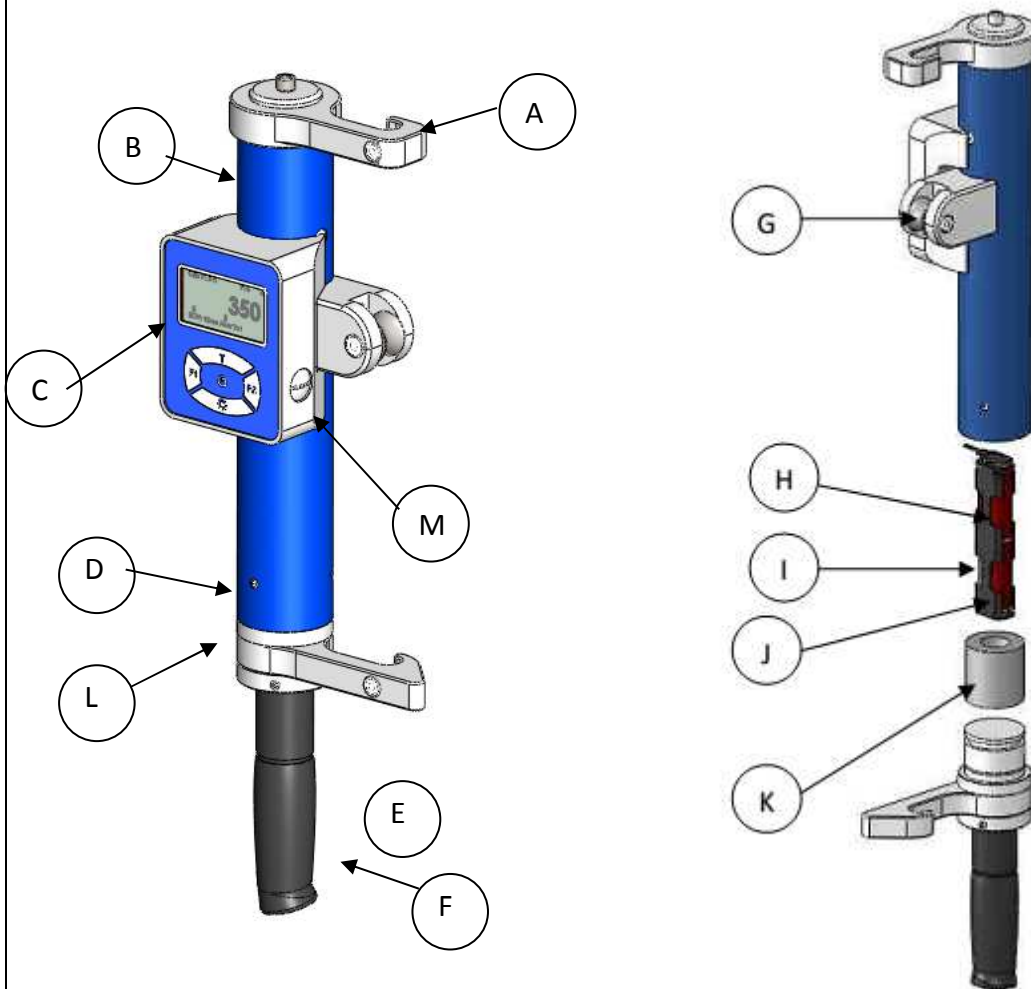

A	Fixed hook	G	Stainless steel wheel
B	Main body	H	3 alkaline cells type "AA"
C	Display	I	Fake alkaline cell
D	Fixation screws (3) to open the battery cells compartment	J	Support for alkaline cells
E	Tilting hook	K	Protective wedging foam
F	Rubber cover handle	L	Positioning mark (on handle and main body)
		M	USB port

5.2. Display information and keyboard functions

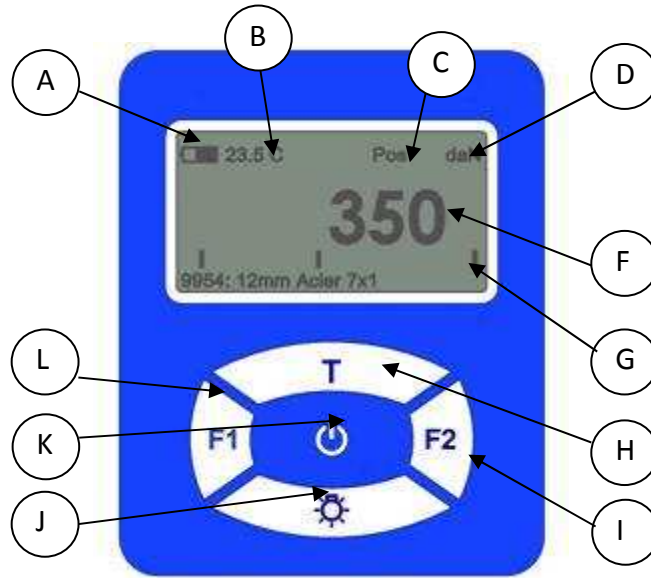

A	Battery level indication	B	Current temperature
C	GPS Status	D	Current unit
F	Current measure		
G	Graphic visualization of the measure between maximum and minimum	H	<p>T Key</p> <ul style="list-style-type: none"> Press 3 sec = increase police of the current measure Auto-off: keeps the device on <p>In MENU Mode</p> <ul style="list-style-type: none"> Press = scroll up
I	<p>F2 Key</p> <ul style="list-style-type: none"> Press = access to wire rope data bank Press 3 sec = access to historical <p>In MENU Mode</p> <ul style="list-style-type: none"> Press = Select 	J	<p>☼ key</p> <ul style="list-style-type: none"> Press 3 sec = Backlight on or off Press = data log <p>In MENU Mode</p> <ul style="list-style-type: none"> Press = scroll down
K	<p>⏻ Key</p> <ul style="list-style-type: none"> Press = ON Press 3 sec = OFF <p>When ON</p> <ul style="list-style-type: none"> Press = access to MENU <p>In MENU Mode</p> <ul style="list-style-type: none"> Press = Enter 	L	<p>F1 Key</p> <ul style="list-style-type: none"> Press = average mode on Press 3 sec = monitor mode on Press 3 sec = current mode off <p>In MENU Mode</p> <ul style="list-style-type: none"> Press = Escape

6. TO CARRY A MEASUREMENT OUT



System is zeroing at the time of initialization.

Connections and initialization (display "ON") must be carried out **prior** to fix the tension meter on the wire rope. It is also necessary to **lay the sensor horizontally** before starting.

- Turn the display "ON", the screen will display :
 - Tractel® logo
 - Parameters setting values
 - Select the references of the wire rope you want to control
 - Press F2 to accede at the data bank
 - Scroll with keys  or T
 - calibration reference number – wire rope diameter – Material – Structure
- e.g.:

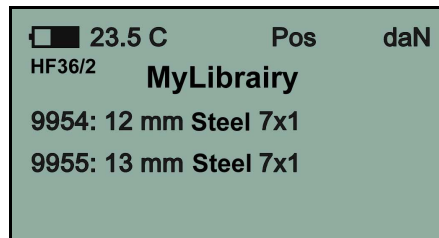

Note: Press F2 for 3 sec to visualize the historical of the previous selections

- Valid your selection with the  key
- Install the tension meter on the wire rope (ref to § 6.1).
- Screen will display (ref to § 5.3) :
 - Current measurement unit
 - Current temperature
 - Battery level of charge
 - Measured effort

Note: MIN = effort below the measurement range of the selected cable
MAX = effort above the measurement range of the selected cable

6.1. To install the tension meter on the wire rope

- Place the fixed hook around the cable and hitch the device by rotating it so that the steel wheel is in contact with the cable.
- The tilting hook automatically locks around the cable when the pressure is enough.

7. CONFIGURATION MENU

- Accede to the Menu by pressing the  key
- Use the key board to scroll the menu (See § 5.2)

ON/OFF		
	PARAMETRES	LANGUAGE
		AUTO OFF
		BACKLIGHT
		TIME
		DATE
		INFORMATION
		RESTORE
	RECORDS	READ
		DELETE
	UNITS	LOAD
		G
		DIAMETER
		TEMPERATURE

- **PARAMETERS**

- LANGUAGE
Available languages are French and English
- AUTO OFF
Setting from "0" up to "60" minutes
- BACKLIGHT
Setting from "0" up to "60" minutes
- TIME
Set your local time
- DATE
Set your local date
- INFORMATION
About the display
- RESTORE
To restore the factory setting (Except TIME and DATE)

- **RECORDS**

- READ
Read the previous logged operations
- DELETE
To clear the memory

- **UNITS**

- LOAD UNITS
N, daN, kN, kg, lbf, lbs
- "g" COEFFICIENT
Modify the default parameter : 9,81
- DIAMETER
Available units: mm, decimal inches, fraction inches.
- TEMPERATURE
Available units : C° and F°

8. ADVANCED FUNCTIONS

AVERAGE – F1	
RECORD – 	
CUSTOM CALIBRATION – F2	CREATE
	USE
	DELETE
MONITOR – F1	

8.1. Average

The tension meter can display the average tension from up to 5 consecutive measures.

- While taking a measure, press F1 during 2 seconds to activate the average mode
- The current effort is displayed on the main screen and on the bottom you can read:
 - AVG – the average effort – (1) which indicates that the average is captured from only 1 measure
- Take another measurement and shortly press on F1 to add this second measure to the computation of the average. The display then shows:
 - AVG – effort – (2) which indicates that the average is captured from 2 measures.

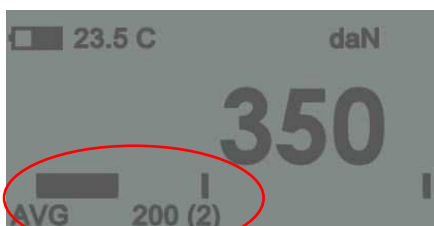

- Repeat the operation with up to 5 measurements. If you try to add a 6th measurement, the error message “!” will appear.
- Press F1 during 2 seconds to leave the average mode

8.2. Record

To record the data at the end of a measurement process

- Press key "☼" during the measurement process, display will show "REC"
- Conditions : Wire rope selected / Batteries OK
- In average mode, the value recorded is the average value and not the current effort

Note: the effort must be an actual value (neither "-MIN-" nor "-MAX-») otherwise, the display shows the error message “!”

8.3. Custom calibration

8.3.1 Create

This process (carried out by user) allows to correct the “raw effort” signal provided by the sensor.



The special calibration is valid for only one type of cable at a single value of effort. This operation must only be performed using the unit daN both on the tension meter and on the dynamometer (see § 7).

To perform a custom calibration, place an online dynamometer in the installation and apply the desired tension in the cable.

- Press F2 and select the cable -- Special -- (first line of the list)
- Select a blank line “Spc xx /”. Press F2
- Select "Calibrate" with key ⏏ to create a new calibration
 - "Use" see § 8.3.2
 - "Delete" to delete an existing custom calibration
- Install the tension meter on the cable (see § 6.1)
- Your display shows the “raw effort” (see § 4.1).



Make sure the raw effort never is above 20.000 (daN). If it is the case, take the tension meter off the cable, go back with the F1 key.

Change the position of the stop block for a higher position and start again.

- To have enough signal, the raw effort must be higher than 2.000
- Press the ⏏ key
- Adjust the value shown by the display at the same value as shown by the dynamometer using keys T and ☼
- Save the value with ⏏
- End process with F1
- The display shows the current effort with, at the bottom left of the screen, the reference of the custom calibration

8.3.2 Use

- Press F2 and select the cable -- Special -- (first line of the list)
- Select an existing custom calibration
 - Select "Use" with key ⏏ to use the custom calibration
- The display shows the current effort with, at the bottom left of the screen, the reference of the selected custom calibration and the value of the calibration



The effort will only be precise at this calibration value. At any other value, the precision cannot be guaranteed.

8.4. Monitor

The monitor function allows you to launch an automatic acquisition sequence, i.e. recording during a specified period at a specified interval, variations of effort on a cable (maximum 999 acquisitions).

The operating data recorded via the monitor function requires LOADER MONITOR software option.

- Press 3 sec to turn Monitor mode on
- Set the interval time in seconds (from 1 to 60) with the keys T and ⏏
- Validate with ⏏

The automatic recording has started and is displayed at the bottom left of the screen :

- The countdown till the next recording (based on the set interval) – current measure – between brackets the number of measurements recorded

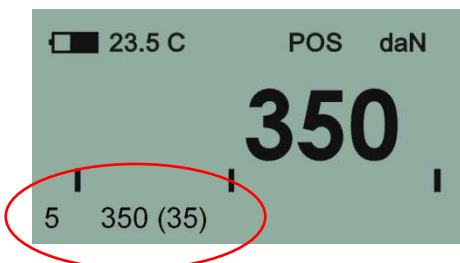

- Press F1 for 3 sec to leave the Monitor mode

Note: the effort must be an actual value (neither "MIN" nor "MAX") otherwise, the error message "!" appears.

9. MAINTENANCE, CHECKING AND CLEANING

9.1. Changing batteries

- Turn the display OFF
- Unscrew de fixation screws of the handle and extract the battery compartment block.
- Pull out the batteries cover with the string attached to it.
- Replace the 3 batteries and respect polarities (leave the fake cell in place)
- Place back the battery compartment and screw back the handle



Take care to replace the handle correctly : the positioning mark of the handle must match the one on the main body.

9.2. Regulatory check

New appliances come with a certificate of adjustment. This document indicates the values obtained during adjustment and certifies that the sensor has been adjusted, in compliance with an in-house procedure, on a calibration bench with its calibration sensor connected to the International Standard calibrator.

Tractel® recommends an annual metrological check for every appliance.

9.3. Maintenance

The sensor/display unit requires no specific maintenance other than a regular cleaning with a dry cloth.

10. MESSAGES

10.1. Information messages

Message	Cause	Solution
-----	No wire rope selected.	Select a wire rope (§ 6)
- MIN -	Current effort is below the measurement range of the selected wire rope.	Apply tension in the wire rope.
- MAX -	Current effort is above the measurement range of the selected wire rope.	Lower the tension in the wire rope.
!!!!	Current effort is way above the measurement range of the selected wire rope.	Lower the tension in the wire rope.
Auto Off : xx S	Announcement of the imminent extinction of the device.	Press key "T" to reset the counter.
TIME	Automatic extinction of the device.	
BAT	Automatic extinction of the device due to low batteries condition.	Replace the alkaline cells (see § 9.1)

10.2. Error messages

Message	Cause	Solution
Corrupted signature	Error in the wire rope parameters.	Use the optional « LOADER » software to update the data bank. Or, consult the manufacturer.
Corrupted math	Error in the wire rope parameters.	Use the optional « LOADER » software to update the data bank. Or, consult the manufacturer.
Unknown error	Unidentified error.	Consult the manufacturer.
!	See conditions § 8.1, 8.2 or 8.4	See § 8.1, 8.2 or 8.4
AD-L	The output signal from the tension meter is too low.	Consult the manufacturer.
AD-H	The output signal from the tension meter is too high.	Verify that the sensor is not overloaded. Consult the manufacturer.
Z-er	The system cannot zeroing. Connection problem between the tension meter and the display.	Consult the manufacturer

11. PRODUCT MARKINGS

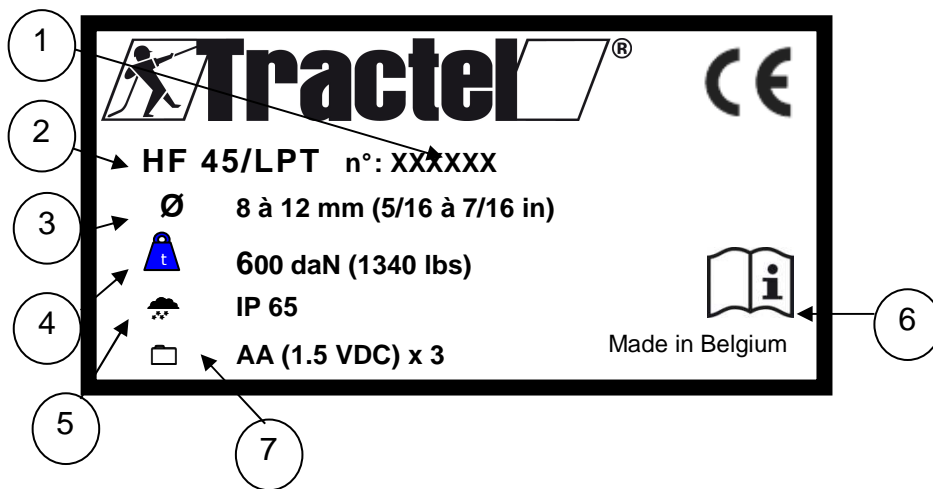

1	Serial number
2	Identification (TYPE)
3	Wire rope diameters range
4	Maximal capacity
5	Protection rating
6	Symbol « Read the instruction Manual »
7	Power supply