

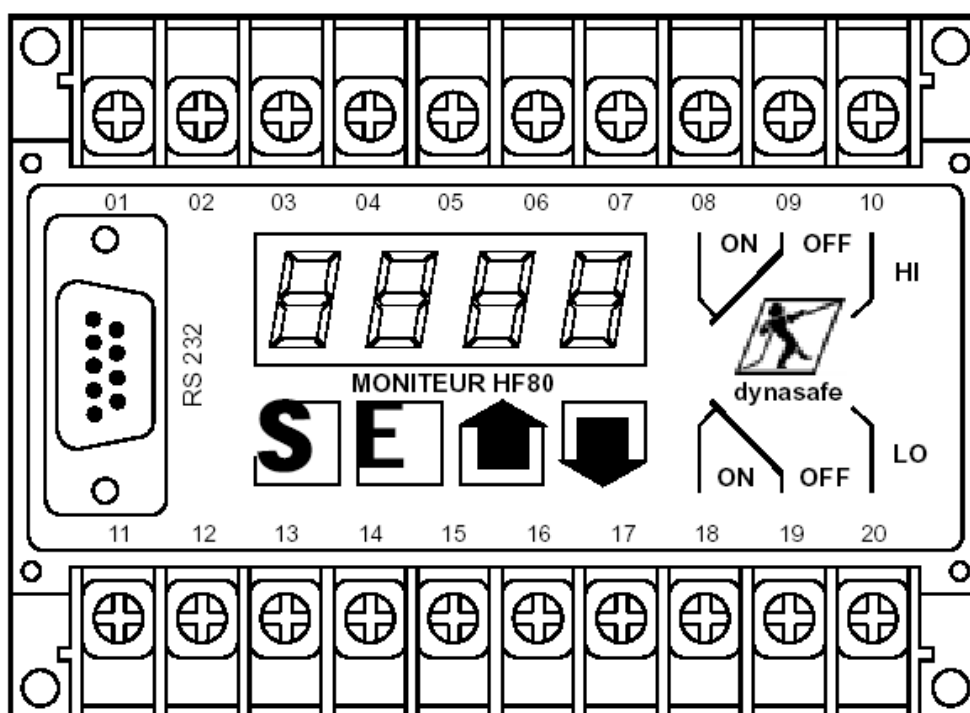

“Intelligent” monitors HF 80/1 and HF 80/2



Equipment in
accordance with
CE directives

**Operating
and
Maintenance
Instructions**

CONTENTS

GENERAL WARNING	3
INSTALLATION AND CONNECTION OF MONITOR HF80/1	4
CONNECTION OF ELECTRONIC LOAD CELL POWER SUPPLY CONNECTION	5
TEST FUNCTION	6
CONNECTION LAYOUT 1 SAFETY TRIP POINT + 1 INTERMEDIATE TRIP POINT	7
CONNECTION LAYOUT 1 SAFETY TRIP POINT + 1 SLACK WIRE ROPE TRIP POINT	8
GRAPHIC REPRESENTATION OF A LOADING CYCLE	9
DEFINITIONS AND ABBREVIATIONS	10
ADJUSTMENTS AND/OR MANUAL CORRECTION OF PARAMETERS OF MONITOR HF80/1 - SETUP N°1	11
AUTOMATIC SETTING OF SAFETY TRIP POINT FOR MONITOR HF 80/1 - SETUP N° 2	12
AUTOMATIC SETTING OF SAFETY TRIP POINT AND INTERMEDIATE TRIP POINT FOR MONITOR HF80/1 - SETUP N°2	13
AUTOMATIC SETTING OF SAFETY TRIP POINT AND SLACK W.ROPE TRIP POINT FOR MONITOR HF80/1 - SETUP N°2	14
SETTING MORE THAN 2 TRIP POINTS	17
CONNECTING SEVERAL LOAD CELLS TOGETHER	18
ADJUSTMENT OF ZERO AND GAIN POTENTIOMETERS	19
MESSAGES	21
TROUBLESHOOTING	22
INSTALLATION AND CONNECTION OF MONITOR HF80/2	23

GENERAL WARNING

- 1 - Reading and fully understanding the technical data sheets relating to this equipment is essential for the best use of this high technological material that you have received. All the technical data sheets are available on request.**
- 2 - Before installing and operating Dynasafe® equipment it is essential for the safe and correct operation of the material that this manual be read and fully understood and that all the instructions be followed. This manual should be made available to every operator. Extra copies of this manual will be supplied on request.**
- 3 - The installation and operation of Dynasafe® equipment should only be carried out in accordance with the appropriate health and safety at work regulations.**
- 4 - Never apply to the Dynasafe® a load or an effort in excess of the working load limit, and never use it for an operation for which it is not intended.**
- 5 - TRACTEL SA declines any responsibility for the consequences of dismantling or altering the machine by any unauthorized person.**
- 6 - Dynasafe® equipment must not be used in explosive atmospheres.**
- 7 - Dynasafe® equipment must only be used in a system designed for lifting people after ensuring that the appropriate operating coefficients have been used in accordance with the current regulations.**
- 8 - Prior to the use of Dynasafe® equipment with complementary equipment relaying the signals to an operating system, the user or installer of this system should carry out a specific risk analysis of the operating functions. The appropriate measures should be taken to obviate the risks identified.**

INSTALLATION AND CONNECTION OF MONITOR HF80/1

(see details on following page)

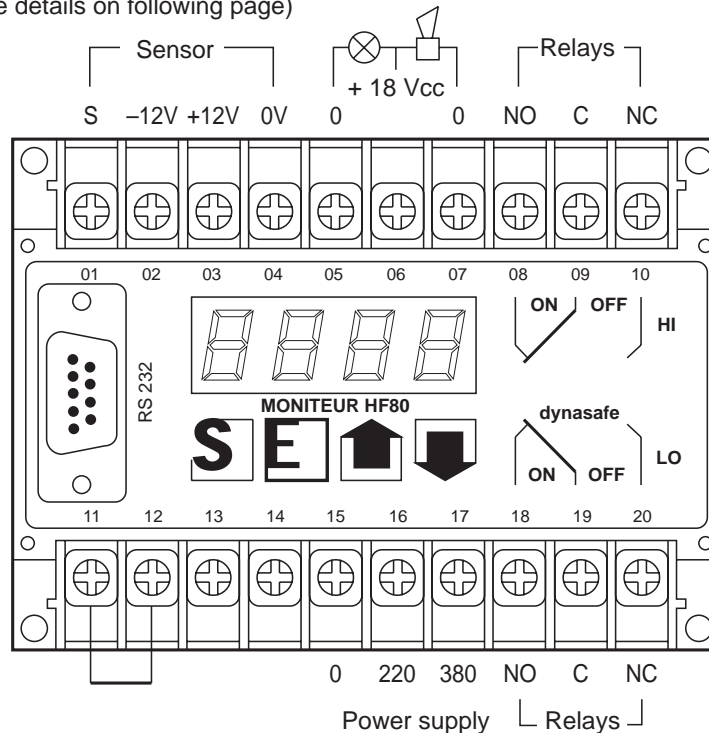

Figure 1

TERMINALS

-01-02-03-04	Sensor	-15 - 16	Power supply 220 (US : 48) Vac
-05 - 06	Flashing light	-15 - 17	Power supply 380 (US : 110) Vac
-06 - 07	Alarm	-18 - 19	Contact NO (10 A/220 Vac)
-08 - 09	Contact NO (10 A/220 Vac)	-19 - 20	Contact NC (10 A/220 Vac)
-09 - 10	Contact NC (10 A/220 Vac)		

- Mount the HF80/1 monitor to the "DIN" rail in the electrical control box containing the lifting controls.
- **Connect the monitor in accordance with the layout above. Observe the correct polarity. Any error in connecting the terminals may cause damage to certain electronic components.**
- Connect the electronic alarm, HF90/1, to terminals 06 and 07 taking care to observe the correct polarity. The alarm function is deactivated automatically 15 seconds after the detection of an overload condition.
- Wire the electronic flashing light, HF90/2, to terminals 05 and 06, taking care to observe the correct polarity. This flashing light function remains active whilst there is an overload condition.

NOTE : It is possible to compensate for the dynamic effects which on lowering could trigger the alarms by wiring terminals 11, 12 and 13,14 as for the HF80/2 (see page 23).

CONNECTION OF ELECTRONIC LOAD CELL POWER SUPPLY CONNECTION

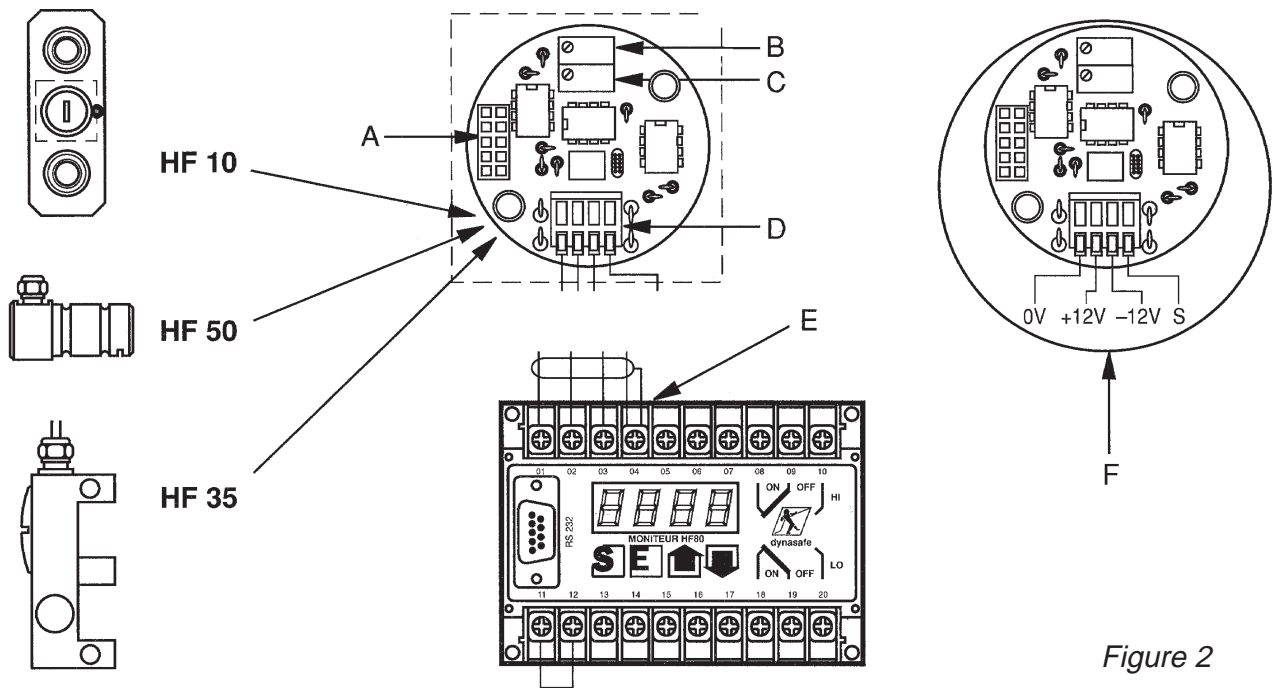

Figure 2

A - Diagnostic socket
 B - Gain potentiometer
 C - Zero potentiometer

D - Connection terminals
 E - Monitor terminals
 F - Label

Power supply connection

When the load cell and the monitor have been fitted and wired correctly, switch on the power supply.

Once the power supply is switched on, the monitor displays the model reference (**80-1** or **80-2**) for 2 seconds, during which time the alarms are triggered and the safety relays reversed.

Then, the monitor displays "ON". Should there be a different message on the display, refer to "Troubleshooting" (page 22).

CONNECTION LAYOUT

1 SAFETY TRIP POINT + 1 INTERMEDIATE TRIP POINT

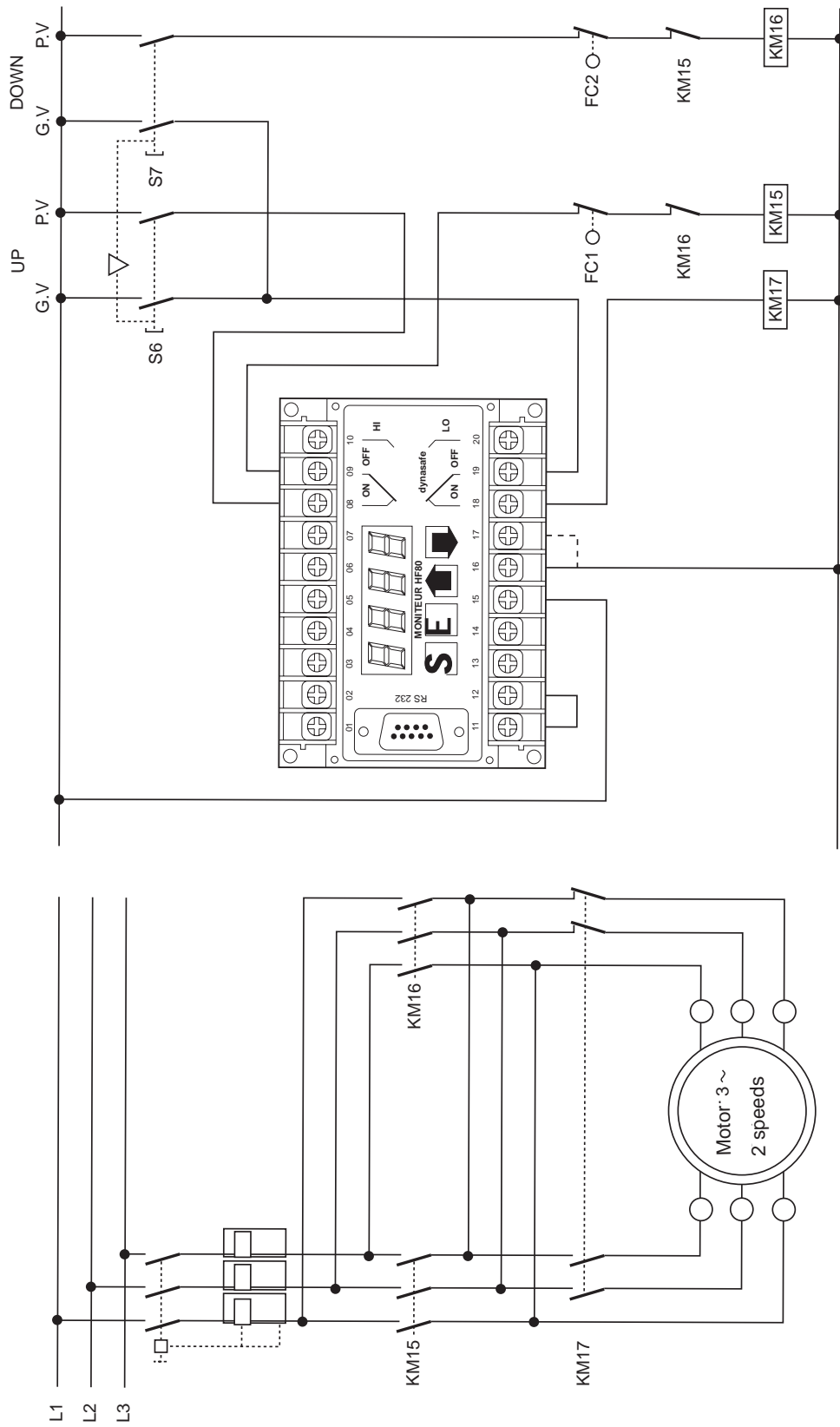

Figure 3

CONNECTION LAYOUT

1 SAFETY TRIP POINT + 1 SLACK W.ROPE TRIP POINT

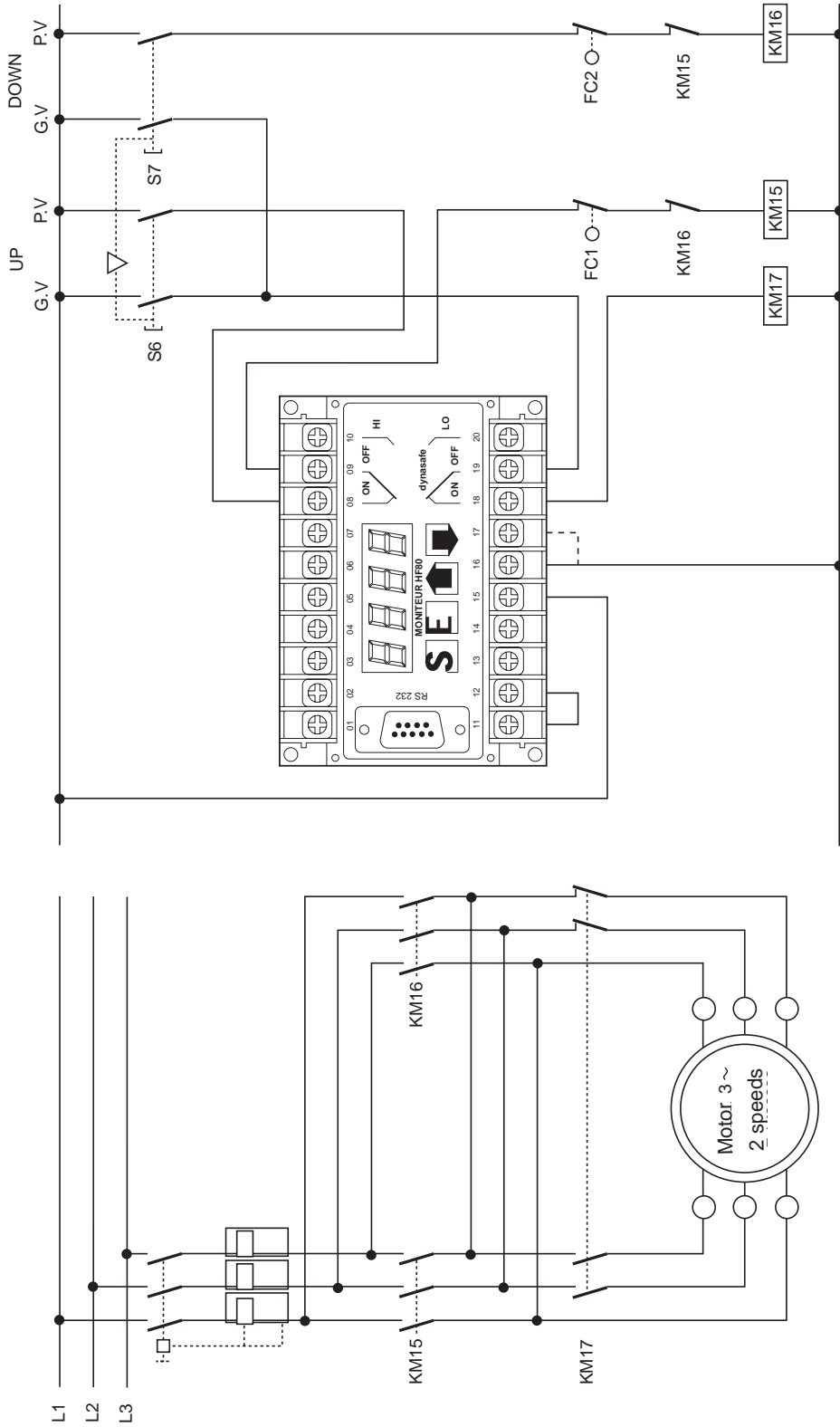

Figure 4

GRAPHIC REPRESENTATION OF A LOADING CYCLE

The frequency signal received by the monitor is directly proportional to the value of the load.

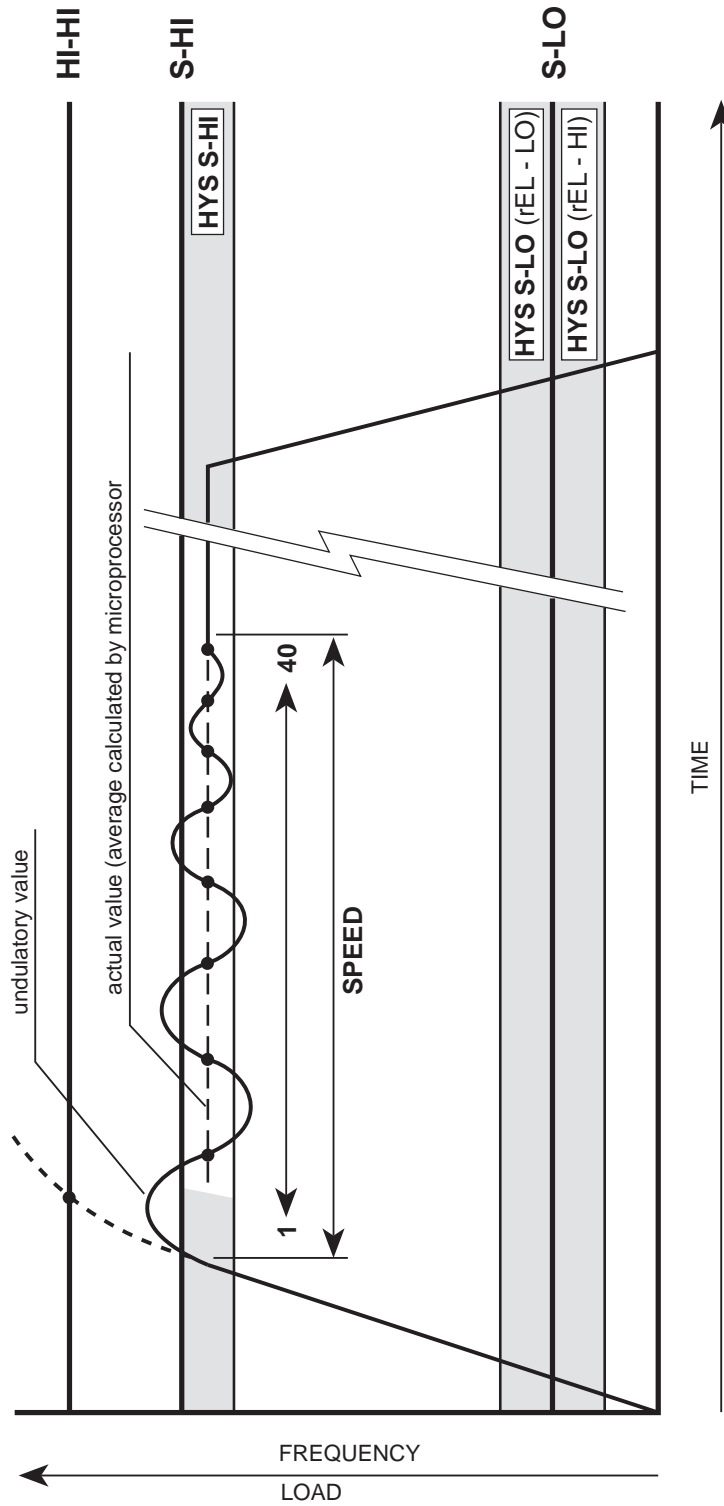

Figure 5

DEFINITIONS AND ABBREVIATIONS

S-HI = Safety trip point

- Value of signal in Hertz (Hz).
- Its value is generally set at 110% of the nominal capacity of the lifting system, but it may be adjusted to any point within the nominal capacity.
- It takes account of the real value of the load and not the undulatory value.
- It sets off the safety and alarm systems at the precise moment when the real value of the load exceeds the trip point.

HI-HI = Final safety trip point

- Value of signal in Hertz (Hz).
- By default, its value is set at 130% of the nominal capacity. This value can be adjusted to a different level as required.
- It takes account of the undulatory value of the load and not the real value.
- It sets off the safety and alarm systems at the precise moment when the undulatory value of the load exceeds the trip point.

S-LO = Intermediate trip point

- Value of signal in Hertz (Hz).
- Optional trip point : if it is not used it sets itself automatically at the same point as S-HI.
- Its value may be set at any level between 0 and the S-HI trip point.
- It takes account of the real value of the load and not the undulatory value.
- It sets off the safety and alarm systems on the LO relay at the precise moment when the real value of the load :
 - exceeds the trip point, when in configuration "HI" (see page 11).
 - falls below the trip point, when in configuration "LO" (see page 11).

HYS S-HI & HYS S-LO (rEL-HI) = Hysteresis

- The value, in Hz, by which it is necessary to reduce the loading to reset the trip points after they have been activated.

HYS S-LO (rEL-LO) = Hysteresis

- The value, in Hz, by which it is necessary to increase the loading to reset the trip points after they have been activated (function : slack wire rope).

rEL-LO & rEL-HI = Configuration of the intermediate trip point

- The intermediate trip point S-LO may be set up in two ways :
 - **rEL-HI** : the relay is operated at the moment when the real value of the load exceeds the trip point. In this case, the trip point serves as an intermediate trip point. For example : not possible to use the fast speed functions where the load handled exceeds a certain value.
 - **rEL-LO** : the relay is operated at the moment when the real value of the load falls below the trip point. In this case, the trip point serves as a "slack wire rope" detector. For example, when using a lifting accessory such as a spreader bar or special clamps, it is possible to automatically stop lowering at the moment when the accessory touches the ground. In this way, we may avoid problems with the wire rope guiding when coming off the winch drum.

SPED - Speed of calculation

- By default, the value is set at 20, on an arbitrary scale of 1 to 40 (40 : slow; 1 : fast).
- Calculation of the real value of the load compared to its undulatory value may be carried out from a greater or lesser figure. The greater the sampling the more complex and precise the calculation. On the other hand, the reaction time of the relays will be longer.

ADJUSTMENTS AND/OR MANUAL CORRECTION OF PARAMETERS OF MONITOR HF80/1 - SET UP N°1

Parameters menu

- Once the access procedure has been completed, the operator gains access to the parameter and/or correction menu.
- Move within the menu to alter the various parameters using the soft-touch push-buttons on the front of the monitor.

= Move to the right, or Reduce a value.
 = Move to the left, or Increase a value.
 = Move downwards, or Confirm a value.
 = Move upwards, or Exit without confirming the new value.

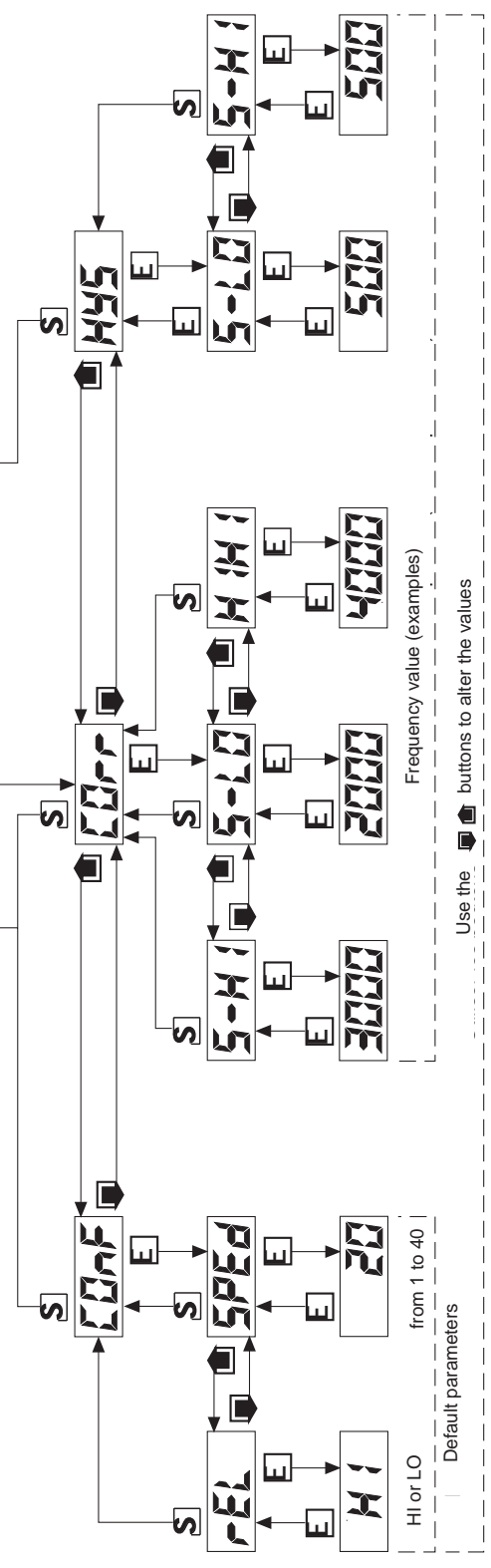
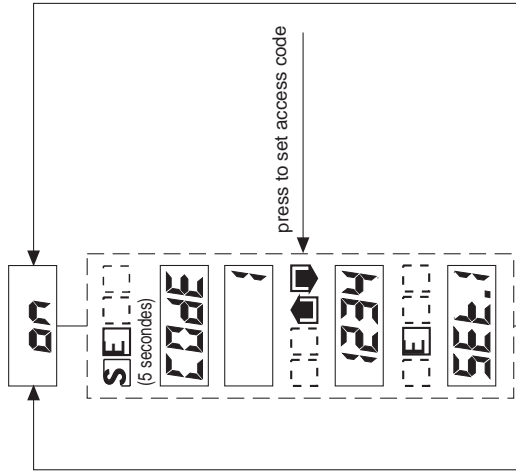
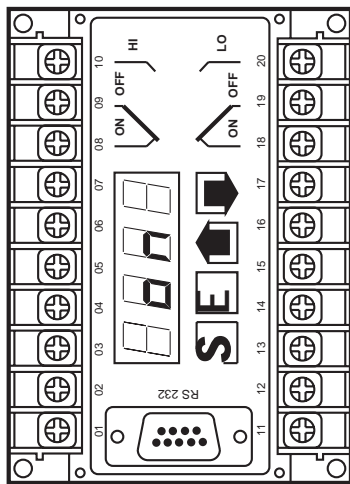









Figure 6

AUTOMATIC SETTING OF SAFETY TRIP POINT FOR MONITOR HF 80/1 SET-UP N° 2

Essential conditions : The load cell and the monitor should be correctly mounted and wired.
The hook of the lifting system should be free of any load.
The test operation should have been successfully carried out
(see page 6).
The relay (rEL) is set by default in "HI" (see page 11).
(If necessary, check through Set-up n°1).

Equipment required : A load equivalent to 100% of the working load limit of the lifting system.

	DISPLAY	ACTION	EXPLANATION
1	ON or LO	S E   (push-buttons)	Display in normal operation. Hook with no load.
2	ON orLO	S E	Press buttons S and E simultaneously for 5 seconds to access the menu for automatic setting of the trip point.
3	CODE	(auto : automatic display)	Monitor ready for entering the access code. "CODE" appears automatically.
4	1	 	Press  to enter the code 2345 ( to correct)
5	2345	E	Confirm the code by pressing E .
6	SEt.2	(auto)	Set-up N° 2 : Automatic setting of the trip points.
7	N°..	(auto)	N° of the lifting system.
8	...6	 	Use the arrows to enter the N° of the lifting system.
9	...6	E	Confirm the N° by pressing E .
10	nUL.	(auto)	Zero. The frequency signal from the load cell will be considered as zero (no load).
11	nUL.	E	Confirm the zero by pressing E .
12	---	(auto)	The four lines are displayed whilst the microprocessor calculates the real value of the load.
13	750	(auto)	Display in Hertz of the system zero. The example shows 750 Hz.
14	S-LO	(auto)	Intermediate trip point which will not be used on this system setting. As a result, the relays HI (terminals 08, 09,10) and LO (terminals 18, 19, 20) will trip simultaneously.
15	S-LO	S	Press button S to skip to setting the HI trip point.

16	S-HI	(auto)	Safety trip point S-HI (see page 10).
17	S-HI	(auto)	Lift a load equivalent to the maximum capacity of the lifting system by about 10 cm (or the maximum permitted load).
18	S-HI	E	When the load is stable, confirm the trip point by pressing button E .
19	----	(auto)	The microprocessor calculates the real value of the load.
20	6750	(auto)	Display in Hertz of the upper trip point (S-HI). The example shows 6750 Hz. The microprocessor calculates this trip point to set it at 110% of the load lifted. The final upper trip point HI-HI is automatically calculated and set at 30% over the safety trip point (S-HI).
21	End	(auto)	End of automatic setting procedure.
22	ON	(auto)	The monitor returns to normal operation.

NOTE : After using the automatic setting procedure using SET-UP N°2, the user has the option of modifying all the trip points and/or the system parameters by using the SET-Up N°1 procedure. (see page 11)

AUTOMATIC SETTING OF SAFETY TRIP POINT AND INTERMEDIATE TRIP POINT FOR MONITOR HF 80/1 SET-UP N° 2

















Essential conditions :

- The load cell and the monitor should be correctly mounted and wired.
- The hook of the lifting system should be free of any load.
- The test operation should have been successfully carried out (see page 6).
- The relay (rEL) is set by default in "HI" (see page 11). (If necessary, check through SET-UP N°1).

Equipment required :

- A load (load N°1) equivalent to the value of the intermediate trip point, S-LO.
- A load (load N°2) equivalent to 100% of the working load limit of the lifting system.

	DISPLAY	ACTION	EXPLANATION
1	ON	S E (push-buttons)	Display in normal operation. Hook with no load.
2	ON	S E (5 sec)	Press buttons S and E simultaneously for 5 seconds to access the menu for automatic setting of the trip points.

3	CODE	(auto : automatic display)	Monitor ready for entering the access code. "CODE" is displayed automatically.
4	1	 	Press  to enter the code 2345 ( to correct).
5	2345		Confirm the code by pressing  .
6	SEt.2	(auto)	Set-up N° 2 : Automatic setting of the trip points.
7	N°..	(auto)	N° of the lifting system.
8	...6	 	Use the arrows to enter the N° of the lifting system.
9	...6		Confirm the N° by pressing  .
10	nUL	(auto)	Zero. The frequency signal from the load cell will be considered as zero (no load).
11	nUL.		Confirm the zero by pressing  .
12	----	(auto)	The four lines are displayed whilst the microprocessor calculates the real value of the load.
13	750	(auto)	Display in Hertz of the system zero. The example shows 750 Hz.
14	S-LO	(auto)	Intermediate trip point (S-LO).
15	S-LO	(auto)	Lift load N°1 about 10 cm.
16	S-LO		When the load is stable, confirm the trip point by pressing button  .
17	----	(auto)	The microprocessor calculates the real value of the load.
18	2750	(auto)	Display in Hertz of the intermediate trip point S-LO . The example shows 2750 Hz.
19	S-Hi	(auto)	Safety trip point S-HI (see age 10).
20	S-Hi	(auto)	Lower the load N°1. Lift load N°2 about 10 cm. <i>note: Up to 4 minutes is allowed to carry out this operation, after which time the monitor returns to normal operation and the set up must restart at point 1.</i>
21	S-HI		When the load is stable, confirm the trip point by pressing button  .
22	----	(auto)	The monitor calculates the real value of the load.
23	6750	(auto)	Display in Hertz of the upper trip point (S-HI). The example shows 6750 Hz. The microprocessor calculates this trip point to set it at 110% of the load lifted. The final upper trip point HI-HI is automatically calculated and set at 130% over the safety trip point (S-HI).
24	End	(auto)	End of automatic setting procedure.
25	LO	(auto)	The monitor returns to normal operation. It displays LO since load N°2 is in excess of the S-LO trip point and it is still suspended on the hook.Lower the load so that there is no load on the hook. The monitor will display ON <i>note : After using the automatic setting procedure using SET-UP N°2, the user has the option of modifying all the trip points and/or the system parameters by using the SET-UP N°1 procedure. (see page11).</i>









AUTOMATIC SETTING OF SAFETY TRIP POINT AND SLACK WIRE ROPE TRIP POINT FOR MONITOR HF 80/1 SET-UP N° 2





Essential conditions : The load cell and the monitor should be correctly mounted and wired.
The hook of the lifting system should be free of any load.
The test operation should have been successfully carried out
(see page 6).

The relay (rEL) is set to "LO" through SET-UP N°1 (see pages 10 and 11).

Equipment required : A lifting accessory (Load N°1) is required for setting the slack wire rope trip point S-LO, eg. a spreader bar, an electro-magnet, etc...

A load (Load N°2) which with the lifting accessory, is equivalent to 100% of the working load limit of the lifting system.

	DISPLAY	ACTION	EXPLANATION
1	ON or LO	S E   (push-buttons)	Display in normal operation. Hook with no load.
2	ON or LO	S E (5 sec)	Press buttons S and E simultaneously for 5 seconds to access the menu for automatic setting of the trip points.
3	CODE	(auto : automatic display)	Monitor ready for entering the access code. "CODE" appears automatically.
4	1	 	Press  to enter the code 2345 ( to correct).
5	2345	E	Confirm the code by pressing E .
6	SEt2	(auto)	Set-up N° 2 : Automatic setting of the trip points.
7	N°..	(auto)	N° of the lifting system.
8	...6	 	Use the arrows to enter the N° of the lifting system.
9	...6	E	Confirm the N° by pressing E .
10	nUL	(auto)	Zero. The frequency signal from the load cell will be considered as zero (no load).
11	nUL	E	Confirm the zero by pressing E .
12	----	(auto)	The four lines are displayed whilst the microprocessor calculates the real value of the load.
13	.750	(auto)	Display in Hertz of the system zero. The example shows 750 Hz.
14	S-LO	(auto)	Intermediate trip point : S-LO (see page 10).
15	S-LO	(auto)	Lift load N°1 about 10 cm.

16	S-LO		When the load is stable, confirm the trip point by pressing button  .
17	----	(auto)	The microprocessor calculates the real value of the load.
18	2750	(auto)	Display in Hertz of the intermediate trip point S-LO. The example shows 2750 Hz.
19	S-HI	(auto)	Safety trip point S-HI (see page 10).
20	S-HI	(auto)	Using the lifting accessory which represents load N°1, lift load N°2 about 10 cm. <i>note : Up to 4 minutes is allowed to carry out this operation, after which time the monitor returns to normal operation and the set-up must restart at point 1.</i>
21	S-HI		When the load is stable, confirm the trip point by pressing button  .
22	----	(auto)	The microprocessor calculates the real value of the load.
23	6750	(auto)	Display in Hertz of the upper trip point (S-HI). The example shows 6750 Hz. The microprocessor calculates this trip point to set it at 110% of the load lifted. The final upper trip point HI-HI is automatically calculated and set at 130% over the safety trip point (S-HI).
24	End.	(auto)	End of automatic setting procedure.
25	ON	(auto)	The monitor returns to normal operation. It displays ON whilst the suspended load is between trip points S-HI and S-LO (slack wire rope).
26	LO	(auto)	The monitor will display LO and switch the S-LO relay (stopping the lowering operation) as soon as the lifting accessory, on touching the ground, causes the signal from the load cell to fall below the S-LO trip point for slack wire rope. To adjust the hysteresis see pages 10 and 11.

NOTE : After using the automatic setting procedure using SET-UP N°2, the user has the option of modifying all the trip points and/or the system parameters by using the SET-UP N°1 procedure (see page 11).

SETTING MORE THAN 2 TRIP POINTS

By connecting together several monitors, maximum 3, it is possible to control more than 2 trip points from a single electronic load cell (connecting terminals 01 and 04 only in parallel). If your application requires more than six trip points (2 for each monitor) please contact us for further advice.

The procedures for setting up and all the parameters of the trip points remain the same.

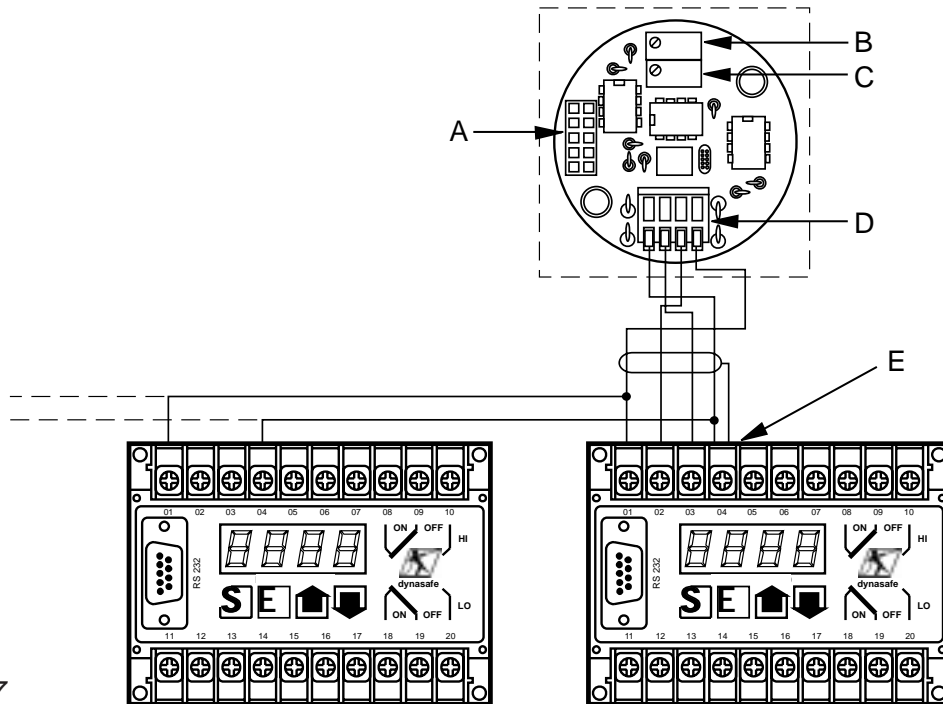

Figure 7

A - Diagnostic socket
 B - Gain potentiometer
 C - Zero potentiometer

D - Connection terminals
 E - Monitor terminals

CONNECTING SEVERAL LOAD CELLS TOGETHER

Several load cells may be connected to cumulate the value of their signals. Three variations are possible :

1 - Processing trip points from load cells close together (maximum 3 m).

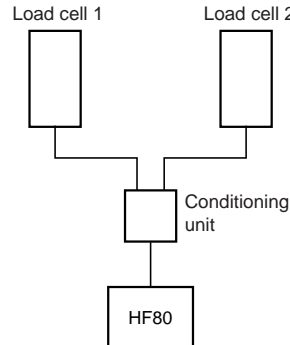

2 - Processing trip points from load cells.

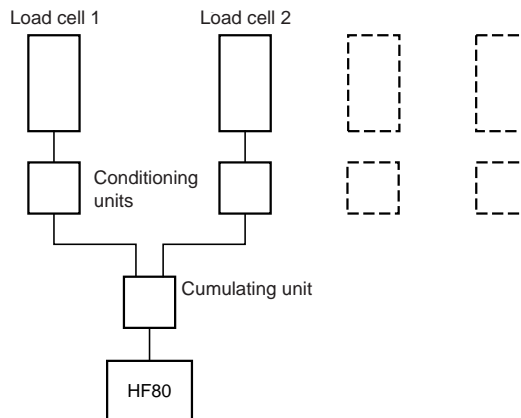

3 - Processing trip points from load cells, individually and collectively.

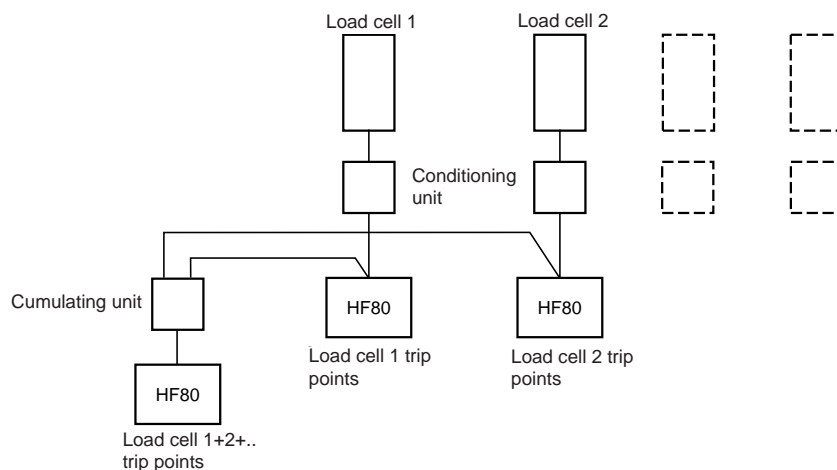

NB : The output signal from HF83 may be used for a display which will indicate the load from all the load cells and which could control the trip points themselves.

The particular applications are supplied with a wiring layout.

ADJUSTMENT OF ZERO AND GAIN POTENTIOMETERS in the electronics of load cells or controls

General information :

- The conditioning units incorporated in the load cells are factory set to give an output of 7000 Hz when the relevant load cell is subjected to its nominal capacity. For a no load condition, the signal is 500 Hz. A frequency of less than 400 Hz is considered as an operating fault (ER20) (see page 22).
- As a result of sheaving or the capacity of the lifting system, the load cell may be used for a part of its nominal capacity, for example 50%. In this case the output frequency will only be 3500 Hz (ie 7000 Hz/2). The effective resolution of the system will be 3000 Hz (ie 3500 Hz - 500 Hz).
- For reasons of sensitivity, particularly when displaying the load applied, it is sometimes useful to have a greater resolution. This can be achieved by increasing the "gain".

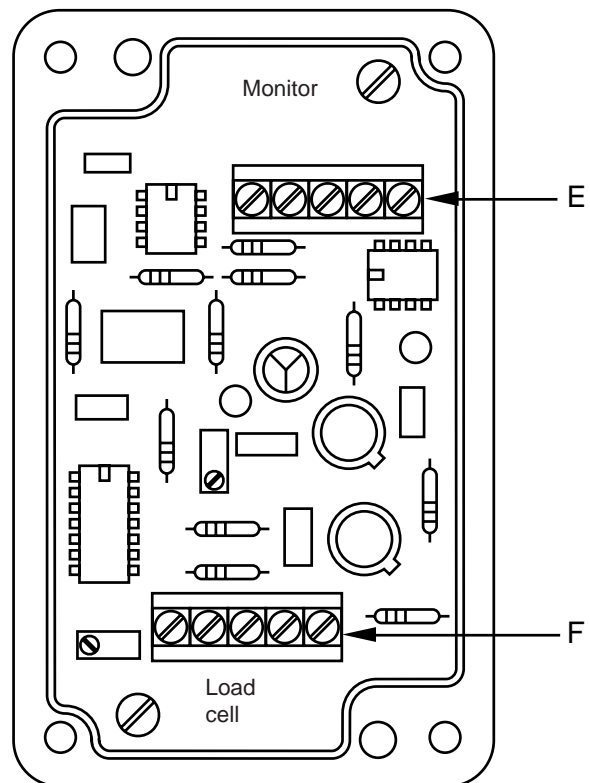
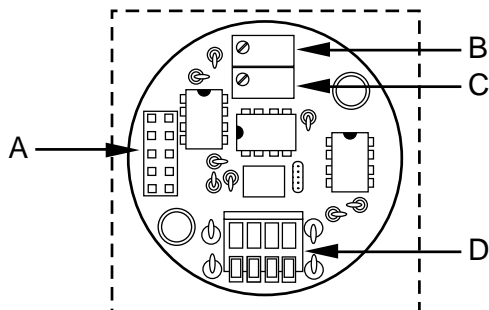

- A - Diagnostic socket
- B - Gain potentiometer
- C - Zero potentiometer
- D - Connection terminals from load cell output to conditioning unit
- E- Connection terminals from conditioning unit output to monitor
- F - Connection terminals from load cell input to conditioning unit

Figure 8

ADJUSTMENT OF ZERO AND GAIN POTENTIOMETERS in the electronics of load cells or controls

Essential conditions : The hook of the lifting system should be free of any load.
The test operation should have been successfully carried out.
Set the display to show the frequency (press button )

Equipment required : A load (denoted "Pm") equivalent to 100% of the working load limit of the lifting system.

	DISPLAY	ACTION	EXPLANATION
1	650		Frequency signal from the load cell at rest (our example).
2	650	Reset to zero	Using the "Zero" potentiometer reduce the value of the frequency displayed to between 1 and 5 Hz.
3	..1		
4		Lift the load "Pm" by 10 cm	
5	2500		Frequency signal from the load cell under the effect of the load lifted (our example : 2500).
6	7000	Adjust the "Gain" potentiometer	Increase the gain until the maximum value is displayed (anti-clockwise direction) Turn 3 times in clockwise direction. <ul style="list-style-type: none"> • If the display shows a value greater than 7000 Hz, continue to turn until 7000 Hz is reached • If the display shows a value of less than 7000 Hz, leave it at this position.
7		Lower the load	
8	..27		Frequency signal from the load cell at rest (our example 27).
9	.500	Adjust the "Zero"	Using the "Zezro" potentiometer, increase the value of the signal to 500Hz.

End of adjustment procedure.

The user may now set the system parameters of the monitor by using SET-UP N°1 and N°2 procedures.

MESSAGES

DISPLAY	EXPLANATION
t E S t	Automatic test on switching on power.
ON	Normal operation. Terminals 08..09 ON 09..10 OFF Terminals 18..19 ON 19..20 OFF
LO	Normal operation. The S-LO trip point has been operated. Terminals 08..09 ON 09..10 OFF Terminals 18..19 OFF 19..20 ON
HI	Normal operation. The S-HI trip point has been operated. Terminals 08..09 OFF 09..10 ON Terminals 18..19 OFF 19..20 ON
HI-HI	Normal operation. The HI-HI final upper trip point has been operated. Terminals 08..09 OFF 09..10 ON Terminals 18..19 OFF 19..20 ON
SEt 1	Set-up N° 1 procedure for configuration and correction of parameters (see page 11).
SEt 2	Set-up N° 2 procedure for automatic setting of trip points. (see page 12)
COde	Enter code to access set up procedure required (see page 11).
COrr	Correction : adjustment menu for trip points (see page 11).
ConF	Configuration : menu for relay and speed parameters (see page 11).
HYS	Hysteresis : resetting value of trip points (see page 11).
rEL	Relay : operation of the S-LO trip point (see page 11).
SPEd	Speed of calculation of the real value of the load (see page 1).
N°	N° of the lifting system (see pages 6 and 12)
3.11	Program version (see page 6).
End	End of procedure (see page 6).
ErOr	Incorrect code number.
80-1	Model of monitor.

TROUBLESHOOTING

DISPLAY	CAUSE	REMEDY
ER.20	<p>The frequency signal from the load cell is less than 400 Hz.</p> <p>1) Signal between 1 and 399 Hz.</p> <p>2) Signal = 0 Hz</p> <ul style="list-style-type: none"> - Wiring fault - Faulty power supply - Faulty monitor - Faulty load cell <p>NOTE : An inversion of the polarity of the power supply to the load cell could cause permanent damage to several electronic components.</p>	<p>To display the frequency from the load cell, press the Down button .</p> <p>1) Increase the frequency value over 500 Hz by adjusting the potentiometer for "Zero". For this, follow the instructions on pages 19 and 20 "Adjustment of zero and gain potentiometers".</p> <p>2) - Check the wiring</p> <ul style="list-style-type: none"> - Check the power supply - Refer to After Sales Service - Refer to After Sales Service
ER.21	<p>The frequency signal from the load cell cannot be processed by the monitor.</p> <p>The signal is over 9999 Hz.</p> <ul style="list-style-type: none"> - The load cell is being operated beyond its capacity. - Faulty monitor. - Faulty load cell. <p>NOTE : An inversion of the polarity of the power supply to the load cell could cause permanent damage to several electronic components.</p>	<ul style="list-style-type: none"> - Check the capacity and the requirement for the application. - Refer to After Sales Service. - Refer to After Sales Service.

INSTALLATION AND CONNECTION OF MONITOR HF 80/2

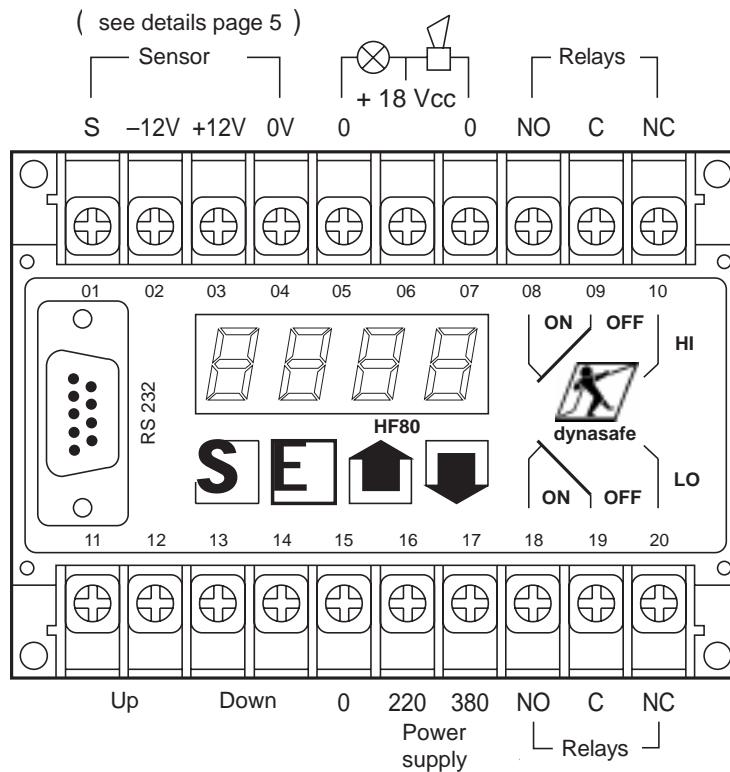

Fig.9

TERMINAL

-01-02-03-04	Sensor	-13 - 14	Contact NO Down
-05 - 06	Flashing light	-15 - 16	Power supply 220 (US : 48) Vca
-06 - 07	Alarm	-15 - 17	Power supply 380 (US :110)Vca
-08 - 09	Contact NO (10 A/220 Vac)	-18 - 19	Contact NO (10 A/220 Vac)
-09 - 10	Contact NC (10 A/220 Vac)	-19 - 20	Contact NC (10 A/220 Vac)
-11 -12	Contact NO Up		

- Mount the HF80/2 monitor to the "DIN" rail in the electrical control box containing the lifting controls.
- **Connect the monitor in accordance with the layout above. Observe the correct polarity. Any error in connecting the terminals may cause damage to certain electronic components.**
- Connect the electronic alarm, HF 90/1, to terminals 06 and 07 taking care to observe the correct polarity. The alarm function is deactivated automatically 15 seconds after the detection of an overload condition.
- Wire the electronic flashing light, HF 90/2, to terminals 05 and 06, taking care to observe the correct polarity. This flashing light function remains active whilst there is an overload condition.
- Connect terminals 11 and 13 via a NO potential free contact on the UP contactor.
- Connect terminals 13 and 14 via a NO potential free contact on the DOWN contactor.

Note : Connecting terminals 11, 12 and 13, 14 in accordance with the above instructions increases the value of the S-HI safety trip point by 20% during lowering operation. The dynamic effect is greater on lowering than on lifting, which could otherwise trigger the alarms.